

Walnut Creek Cart Shop 3309SR39 Millersburg, Oh. 44654

Phone 330 / 893 - 1097VM

Horse Drawn Vehicles

Toll Free 1-866-453-4836

Fax 330 / 893-1097

Surrey Wagon



Open Surrey Wagon
96" by 30" Box

Fiberglass Seat, Rubber Tire wheel.

Patent Covered Dash Vinyl Upholstery seats.

Horse Shaft Hydraulic Brake

Hinged End Gate

Back Seat Removable

\$3800.00

Double Face Light and Battery

Antique Carriage Restoration

New Custom Built Carriages

Wooden Wheel Repaired

Buggy Parts and Repaired

Shop hours are 7Am to 5Pm, Mon.- Fri.

The best way to contact me, is by calling our voice mail phone, 330/893-1097.

If you need to talk, give me your number and a good time to call and I will get back to you.

We ship Fed Ex, Parcel Post, Common Carrier Truck, call our number for freight costs.

3 Kentucky Breaking Cart



KENTUCKY BREAKING CART

This is an extra fine breaking cart. It is especially well constructed throughout. Furnished regularly with rear floor, floor step, seat, and foot rest, as illustrated. All parts are made very strong and we highly recommend this cart to anyone wanting the very best that can be had in a breaking cart.

BODY: Seat measured 16" x 46". Splash board in front securely attached and strongly braced. Rear step measures 10" x 40". Well ironed and braced.

WHEEL: Bolted hub. 1¼" spoke. 1⅝" rim. Fitted 1" half round steel or rubber tire.

SPRING: Full elliptic 1¼", 4-leaf, oil-tempered alloy steel. Securely mounted and clipped.

AXLE: 1" with tapered roller bearings. 57" track. Fitted with best high grade alloy steel.

SHAFTS: Extra heavy, 6" x 10' long. Thoroughly seasoned hickory.

PAINT: Gloss black automotive finish.

UPHOLSTERY: Standard gloss black vinyl covering 3" seat cushion.

LIGHTS: Double-faced LED, 12 volt battery.

PRICE: \$980.00 *with LED lights and battery - add \$175.00

OPTIONS:

Hinged Seat Back \$60.00

Split Opening Hinged Seat \$60.00

4
Slatted Floor Cart



SLATTED FLOOR CART—HORSE SIZE

BODY: Slatted wood floor. Rear entry steps. Seat hand rail.

SHAFT: Double bend shaft.

WHEEL: 42" rubber tire.

PRICE: \$960.00



SLATTED FLOOR CART—DRAFT SIZE

PRICE: \$1,080.00

Meadow Brook Cart



MEADOW BROOK CART

BODY: Hickory slatted floor board and dash board. 5" deep accessory tray on dash. Split seat with hinged back. Storage apartment box attached to underneath seat. Left half of seat is hinged, folds up for easy entry.

WHEEL: Roller bearing bolted hub. 1¼" spoke. 1⅝" rim, on 1¼" flat top rubber tire. Brass hub cap. 44" wheel.

SPRING: 1¼", 4- leaf, 36" elliptic, oil-tempered alloy steel. 1½" x 36" flexi shaft spring.

AXLE: Tempered alloy steel. 1⅝" x 56" track. Bent for plum spoke for wheel.

SHAFTS: Standard horse size, 26" wide at front x 84" long. Straight heel, 1¾" x 2¼", mortised cross bar of selected steam bend hickory. Sword end single tree, brass end tips. Trimmed in black imitation patent vinyl.

PAINT: Automotive urethane, in standard gloss black or your choice of color.

UPHOLSTERY: Fine hand box tufted with buttons in your choice of material style and color. Air foam padded.

DRAFT HORSE BASE PRICE: \$1,280.00

STANDARD HORSE BASE PRICE \$1,100.00

OPTIONS:

Brass Whip Socket \$6.00 Chrome Whip Socket \$8.50

Hydraulic Brake \$415.00

Wooden Fenders \$160.00

Fine Hand Pinstriping \$120.00

Flexi Shaft \$165.00

Painting in Color \$80.00

Brass Rein Rail \$48.00 Chrome Rein Rail \$92.00

Open Buggy—Single Seat Runabout

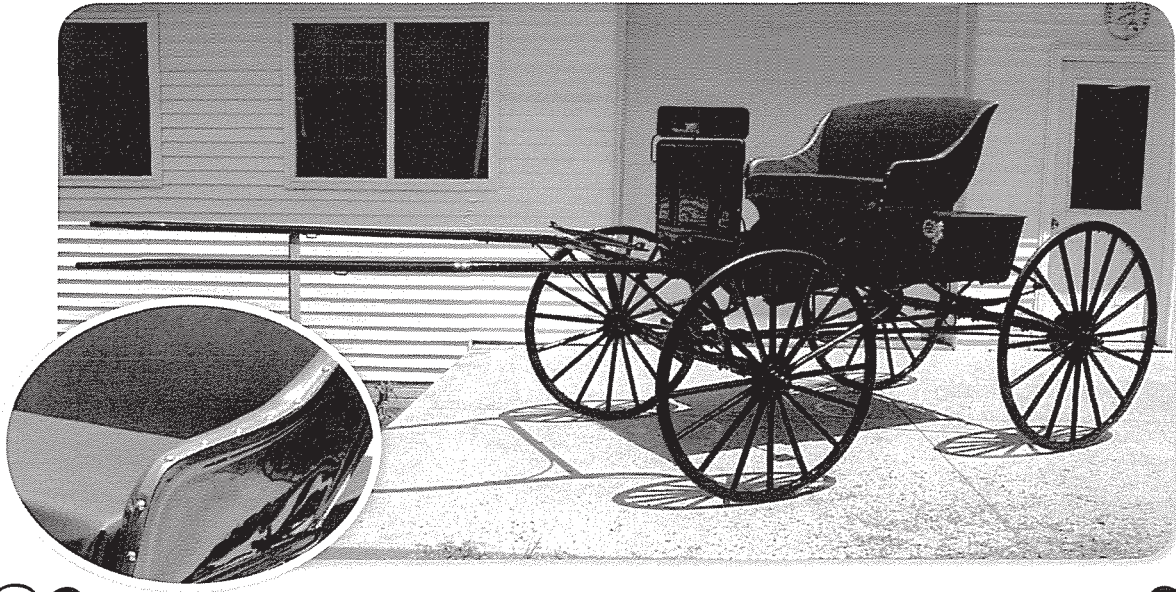

OPEN BUGGY—SINGLE SEAT RUNABOUT

BODY: Hickory framed, plywood panel, 26" wide x 64" long. Hardwood seat, glued, screwed, well braced. Fiberglass seat measures 42" wide at top side panels.

WHEELS: Bolted hub style, $1\frac{5}{16}$ " rim on $11\frac{1}{8}$ " half round tires. Cushion tire - add \$200.00

AXLES: 1" x 58" track, short turn fifth wheel. Square tubing reaches.

BRAKES: Hydraulic 8" rear wheels.

SHAFTS: Steam bent hickory, well ironed and braced. Sword single tree.

UPHOLSTERY: Vinyl in your choice of color.

PAINTING: Urethane, gloss black.

LIGHTS: Double face, with turn signal, strobe flasher on box, 12 volt battery. SMV emblem.

PRICE: \$3,050.00

OPTION: Pinstriping \$240.00

Second seat, removable - add \$320.00

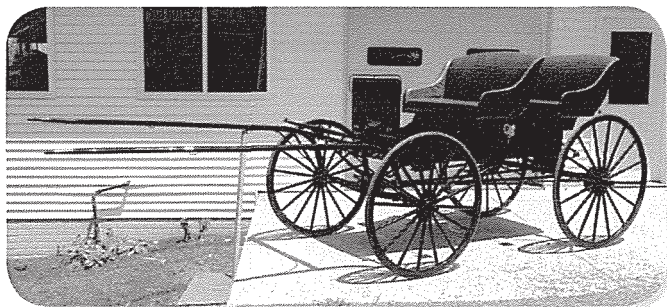

The Pioneer Forecart

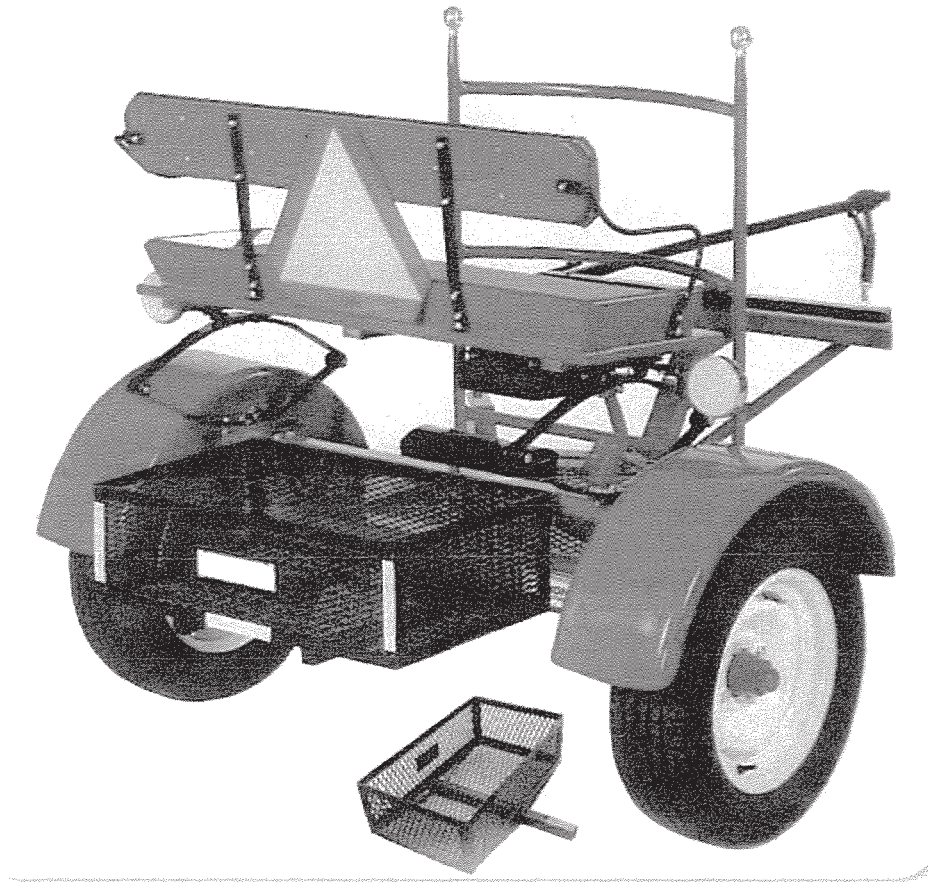

THE PIONEER FORECART

Proven dependable trouble free service on road or farm field. Quality materials and workmanship throughout.

BODY: Expanded metal flooring. Fenders. Front Guard.

SHAFT: Shaft or pole for 1 or 2 horses.

LIGHTS: LED.

BRAKES: Hydraulic.

PRICE: \$1,960.00

OPTIONS:

Cargo Tray \$185.00

Torsion Axle \$310.00

Pole instead of shaft \$42.00

*NOTE: USED ONE IN STOCK

\$1290.00

Cut Under Extension Top Surrey

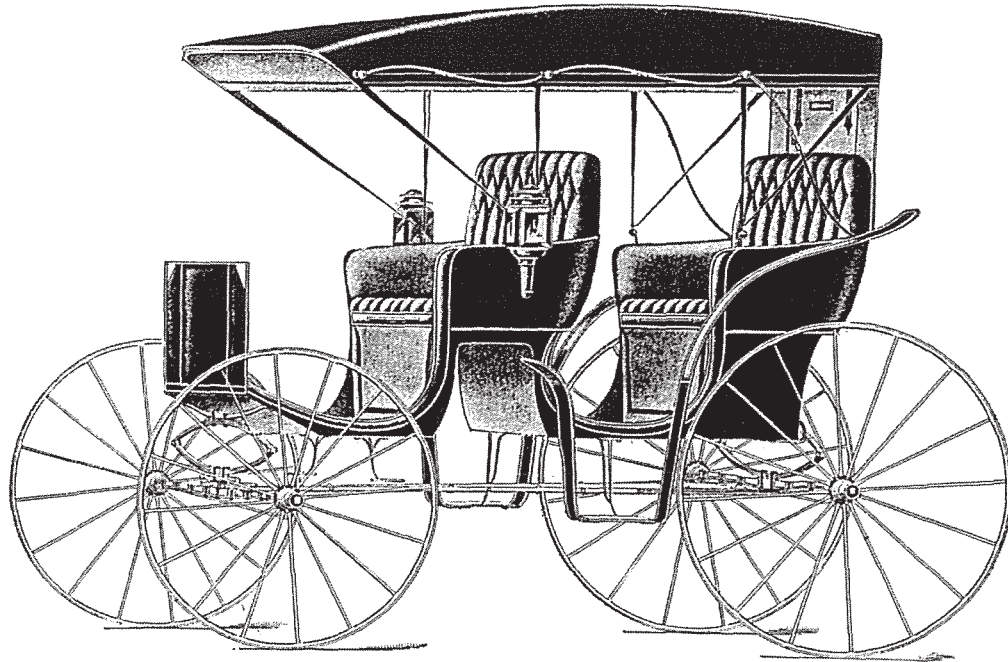

CUT UNDER EXTENSION—TOP SURREY

This surrey is furnished with cut-under body and single-reach gear, allowing front wheels in turning to cut or turn under the body, permitting the making of short turns without the danger of upsetting. It is a well-made, exceptionally nice surrey, suitable for one horse.

BODY: Cut under, full-size body, 28" x 72" long on bottom; hand-molded fiberlass construction, sill ironed and reinforced full length. The seats are very roomy and comfortable and measure 40" across the top of the seat panels.

WHEELS: Bolted 1¼" spoke hubbed wheel, hickory 1½" rim fitted with round top rubber or steel tire, 35" front and 44" rear.

GEAR: Single reach, ironed full-length on bottom, also on sides with stay braces and reinforced with branch braces. Single reach short turn fifth wheel.

SPRINGS: Elliptic style, 1½", 4-plate in front; 5-plate in rear, alloy oil tempered steel.

AXLES: 1½" Timken bearing, oil sealed unit, drop or arched as preferred; full length hickory axle beds, cemented and fully clipped.

TOP: Extra length surrey, extension top with pvc vinyl polyester material non-shrinking back stays and roof. Back curtain complete, lined with velvet of your color choice. cast iron joints; steel bow sockets, enameled. (Four-post canopy fringe top in place of extension top will cost \$?????? less.)

UPHOLSTERY: Very neat, good quality velvets or vinyl in your choice of color and style, air foam cushions, overstuffed hand tufted buttons; measuring 16" x 33". Seat panels padded and lined. Padded dash; with brass line rail.

PAINTING: Alkyd automotive enamel finish; body regularly painted black; gear Brewster green or carmine maroon, rich red, or yellow. (If any other color is preferred, we can furnish them without extra charge.)

SHAFTS: Steam bent hickory, fully ironed and braced surrey shaft; nicely finished and trimmed with imitation patent vinyl.

TRACK: 57" or wide 62".

CASH PRICE: \$3,640.00 plus tax

OPTIONS: Pole in place of shaft	\$225.00	Imitation patent vinyl front and rear fenders	\$290.00
Stylish oil or 12 volt lamps	\$380.00/pr.	Hydraulic Brakes	\$280.00
		Pin striping	\$240.00

Three Spring Wagon

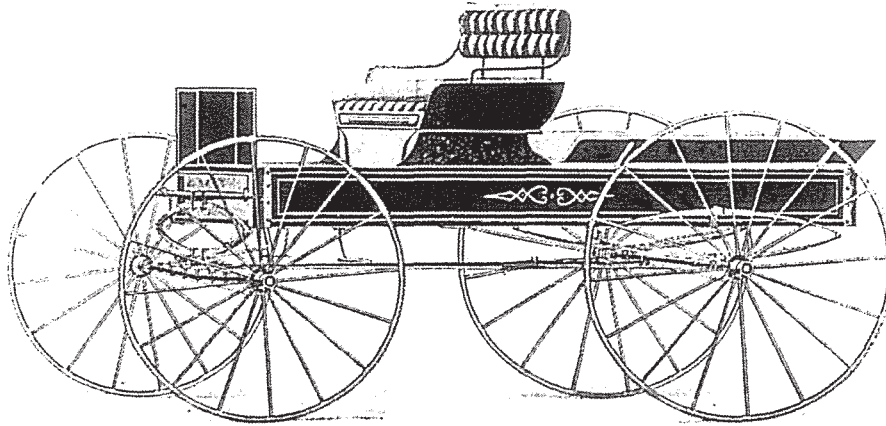

THREE SPRING WAGON

BODY: Thoroughly substantial, 7' long, 33" wide, 8" panels. Floor boards, leather dash, drop end gate. Seat measures 38" across top of seat panels.

WHEELS: Bolted hub, ??ry, fitted with 1" half round steel or rubber tire.

SPRINGS: Alloy steel; 1¼", 4-leaf x 36" in front; two 1½", 3-leaf x 36" inch in back.

AXLES: 1½" x 64" bearing type. Short turn fifth wheel, steel tube reach, well ironed and braced.

BRAKES: Hydraulic 8" Ohio style, rear wheels.

SHAFTS: Hickory, well ironed and braced, sword single tree.

UPHOLSTERY: Seviceable vinyl, foam cushions, 8" lazyback.

PAINTING: Gloss black Alkyd automotive enamel.

PRICE: \$2,980.00

OPTION: Pinstriping \$240.00

Pheaton Cart

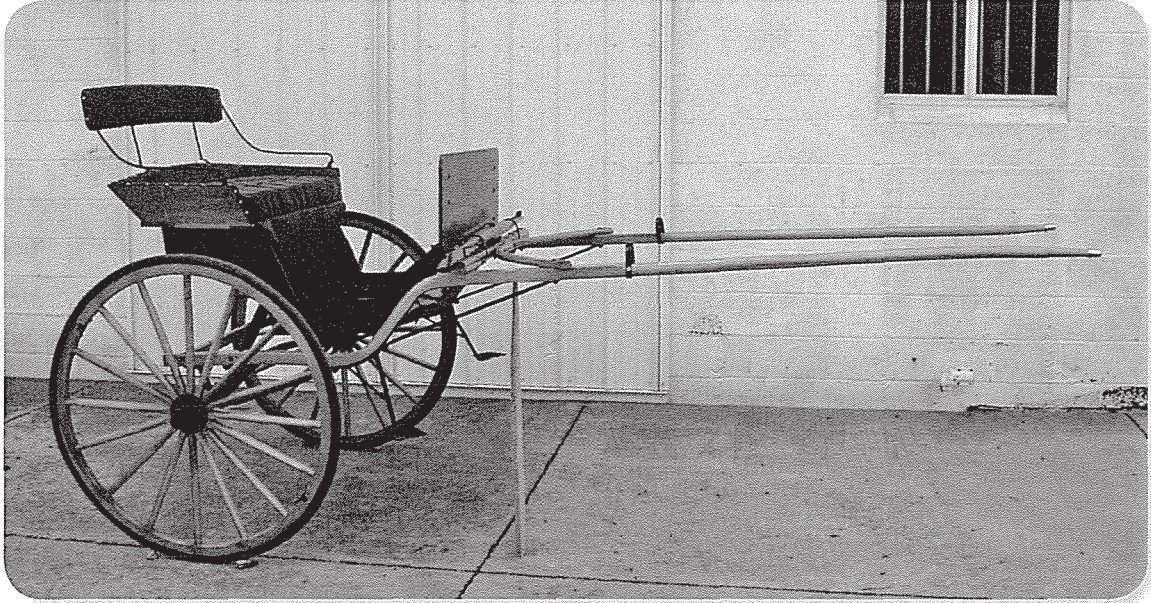

PHEATON CART

BODY: Hardwood frame, seat, and dash. Hickory construction throughout. Easy front wheel entry. Chrome or stainless steel rein rail.

WHEEL: Bolt hub, 38" rubber tire.

SPRING: 1½", 4-leaf, half-elliptic spring.

AXLE: 1" alloy tempered axle.

SHAFTS: Double bend hickory.

PAINT: Black gloss urethane paint, or clear natural finish.

UPHOLSTERY: Button hand tufted cushion.

STANDARD HORSE PRICE \$1,420.00

DRAFT HORSE PRICE: \$1,580.00 *50" wheel

Easy Entry Cart

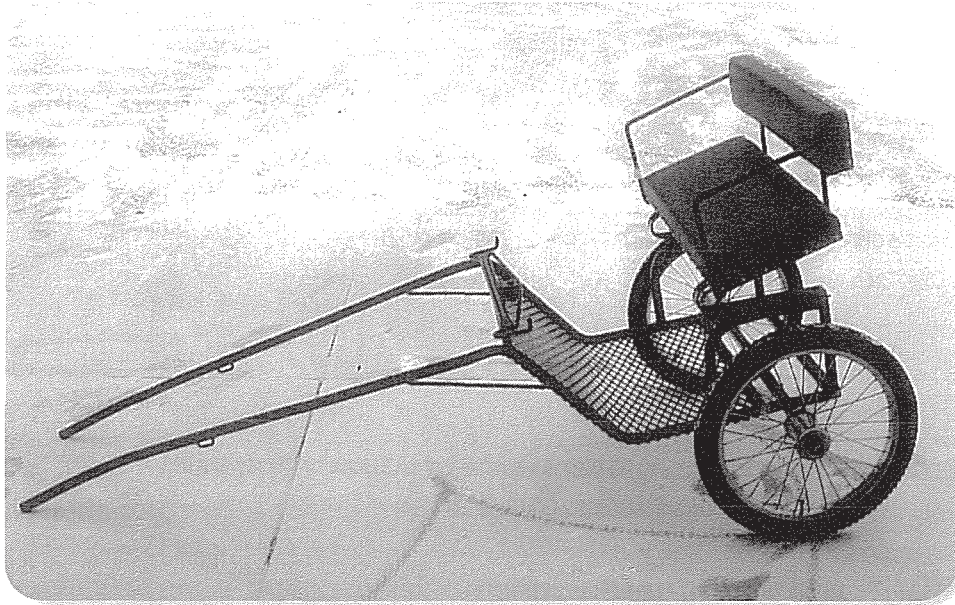

EASY ENTRY CART

BODY: Steel construction.

MINIATURE HORSE SIZE: \$430.00 ea.

PONY SIZE: \$450.00 ea.

HORSE SIZE: \$490.00 ea.

Pony Cart Flag

70", mount plate.
\$7.20 ea.

CUT UNDER SURREY

BODY: 28" x 72" with 40" wide seat. Patent leather padded dash.
Brass reign rail.

WHEEL: 36" x 44" rubber tire.

AXLE: 1 1/8" roller bearing.

BRAKE: Hydraulic.

SHAFTS: Steam bend horse.

PAINT: Black automotive.

UPHOLSTERY: Button tufted seat.

PRICE: \$3,840.00

OPTIONS:

Pole in place of shaft \$235.00

Patent padded fenders \$290.00

12 Volt Lamps \$380.00

Pinstriping \$288.00

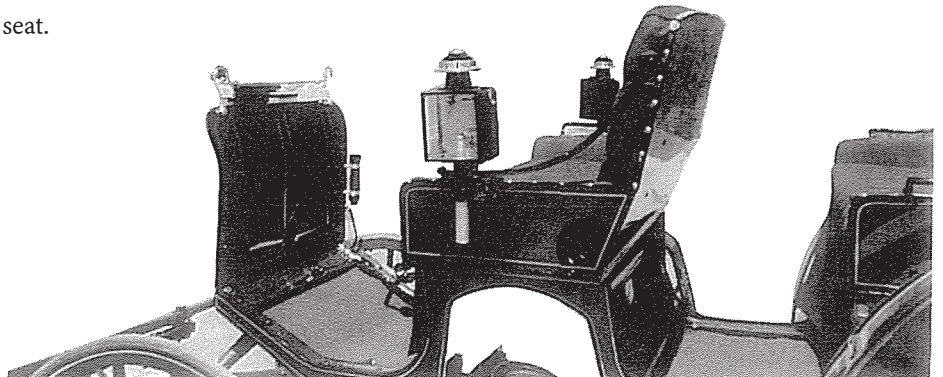
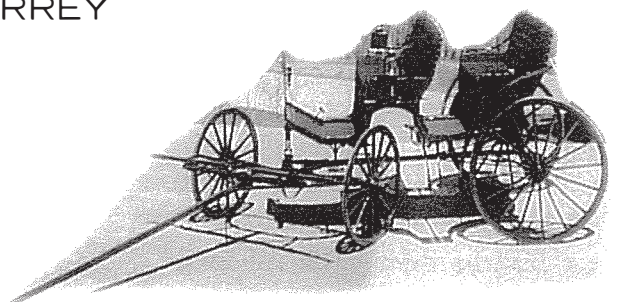

EC Ride Sulky—Rear Entry



EC RIDE SULKY

WHEELS: 26", Flat free tire, 50" tread.

SPRINGS: V Bend, under seat.

SHAFTS: 88" long, Ash.

SEAT: Bench type, padded, 32" long.

PAINTING: Black, urethane gloss.

FLOOR: Adjustable foot rest and mud guard.

PRICE: \$1,050.00

Walnut Creek Cart Co. LLC 3309 SR39 Millersburg, Oh. 44654

330-893-1097

Sleigh Box Sled Steel Bend Runners



Seasoned Poplar Wood Body and Seat	Bed Size	65" by 36"
Steel Bend Runners 2" wide	Horse Shaft	\$1050.00

Antique "Old" Sleighs

Various Styles \$700.00 to \$900.00

Walnut Creek Sulky

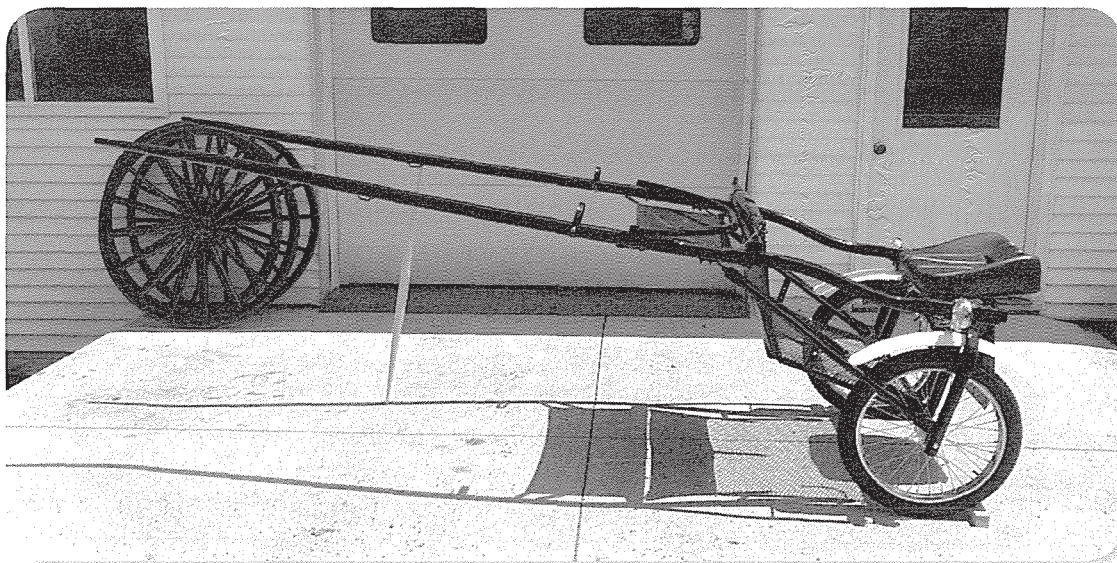

EC RIDE JOG CART

WHEELS: 18" diameter wheel with 2.50" tires on a 40" track.

SHAFTS: 82" long Ash Wood Shaft.

SEAT: Molded Jog Cart Seat

PAINTING: Black Urethane Black

Adjustable floor with vinyl apron at front. LED light with 18 AMP battery. On spring suspension.

PRICE: \$1120.00

Quick Hitch Style Shaft - Add \$40.00

Hitch Wagon

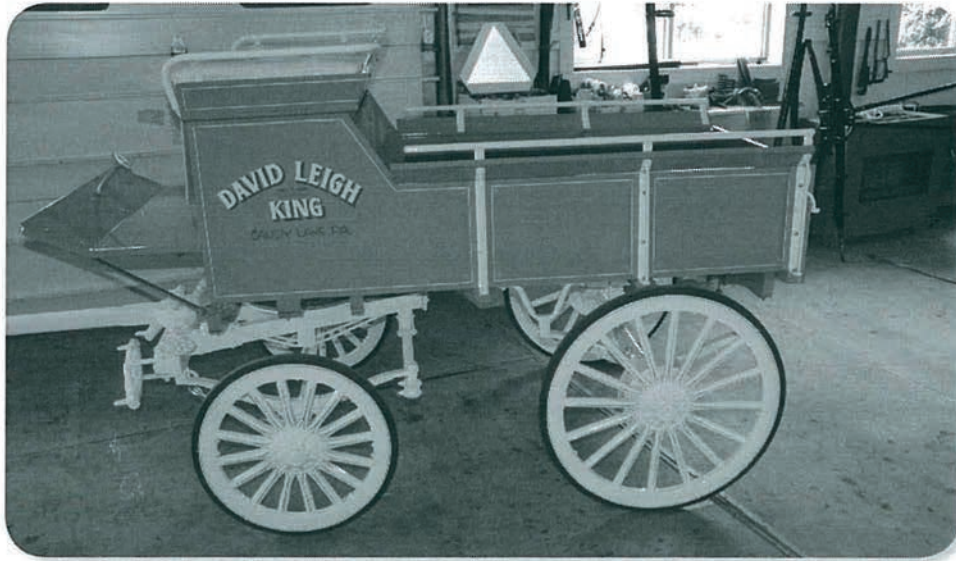

MINIATURE HORSE

WHEELS: 18 - 24 Flush Hub Wheel on rubber tire - 1½" wide with a 43" wheel track.

SEAT: Base Hinged seat with padded hand buttons. Removable seat cushion.

PAINTING: Urethane paint. various colors, hand brushed, pin striped.

GEAR: 16" diameter platform. 5th wheel on 1¼" four leaf. Platform springs. 8" hydraulic brake. Wooden tongue and double tree with swing tongue for multi hitch team. Box: ¾ dura board, plywood, side panel on Hichory wood frame.

Mortisede.

PRICE: \$8,600.00 complete

Ultra Ride Cart—Side Entry



ULTRA RIDE CART

WHEELS: 26" flat free tire with 48" tread.

SHAFTS: Hickory, 80" long, adjustable height for large pony up to horse size, this adjustment keeps floor level.

SEAT: Bench seat, 40" long, V Bend sulky seat spring, storage room under seat, padded cushion.

PAINTING: Urethane Gloss Black

PRICE: \$600.00

WOODEN SPOKE WHEELS 30"-44" DIAMETERS

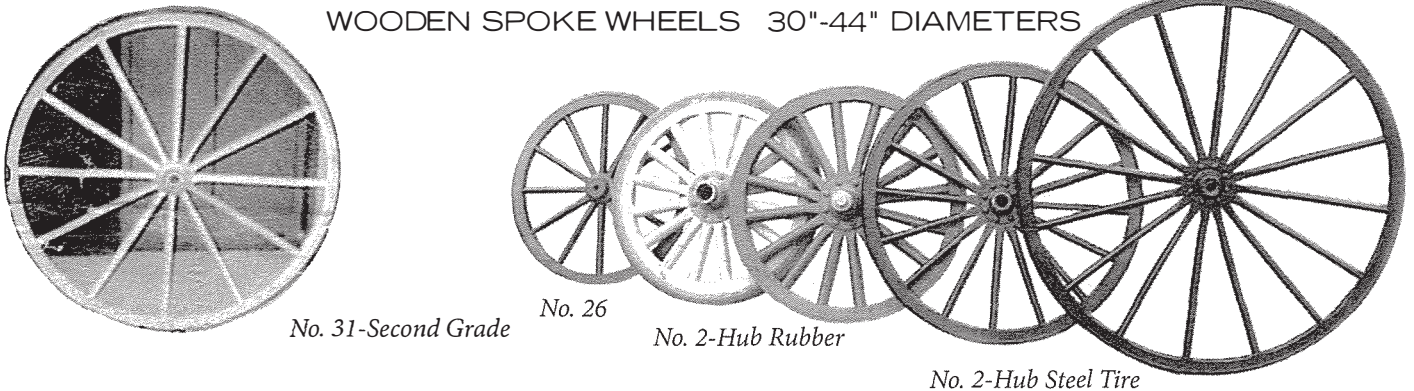

No. 31-Second Grade

No. 26

No. 2-Hub Rubber

No. 2-Hub Steel Tire

- No. 22 Wire Spoke Wheel, air tire, 3/4" bearing, 20" \$52.80 ea. w - \$49.00
- No. 23 Wire Spoke Wheel, flat-free tire, 3/4" bearing, 20" \$68.00 ea. w - \$64.00
- No. 24 Wire Spoke Wheel, air tire, 3/4" bearing, 26" \$52.00 ea. w - \$48.60
- No. 25 Wire Spoke Wheel, flat-free tire, 3/4" bearing, 26" \$84.00 ea. w - \$79.00

- No. 26 18" Jog Cart Wheel Air Tire 3/8" bearing \$140.00 ea.

- No. 27 No. 2 Bolt Hub Wheel, fits 1 1/4" axle, 1 1/2" steel tire \$224.00 ea.
- No. 28 No. 2 Bolt Hub Wheel, fits 1 1/4" axle, 1 1/2" rubber tire \$235.00 ea.
- No. 29 No. 2 Bolt Hub Wheel, fits 1 1/2" axle, 2" steel tire..... \$238.00 ea.
- No. 30 No. 2 Bolt Hub Wheel, fits 1 1/2" axle, 2" rubber tire..... \$296.00 ea.

- No. 31 Second Grade Wheel, 38" steel bands
on wood hub, 1" wide street tire \$74.00 - 4 - \$70.00

- No. 32 Pony Cart Wheel, 3/4" bearing, 1" flat steel \$120.00 ea.
- No. 33 Pony Cart Wheel, 3/4" bearing, rubber tire \$140.00 ea.

Wire Spoke Wheel

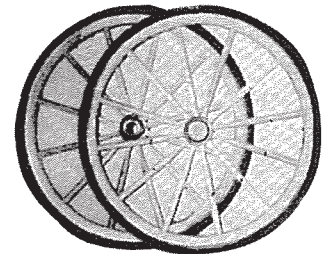
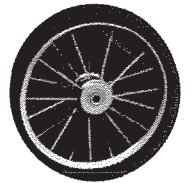

Pony Cart Wheel

Wheel Rims

- 30" to 44" in even numbers.
- 1 1/16" thick, 1 3/8" deep \$12.00 ea. 8 - \$10.50 ea.
- 1" thick, 1 3/8" deep \$12.00 ea. 8 - \$10.50 ea.
- Installed on wheel \$8.00



Axle—1" Square Tube

- 3/4" spindle. Fits wire spoke and pony cart wheel. 30" - 48" long.
\$22.00 ea.

Wagon Bow Clip

- 1/8" x 3/4" Steel. Fits 1/2" x 2 1/2" Bow.
\$0.65 ea. 20 - \$0.55 ea.

Whip Socket

- Wooden. Stainless band. Black or natural wood finish.
- Large whip mount hole.
- \$5.90 ea. 4 - \$5.70 ea. 8 - \$5.60 ea.
- Solid brass Polished.
- \$5.00 ea. 3 - \$4.50 ea. 6 - \$4.00 ea.
- Chrome Plated
- \$6.00 ea. 3 - \$5.50 ea. 6 - \$5.00 ea.

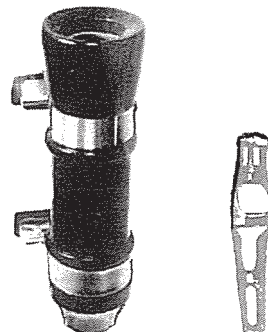

Whip

- 6" drop.
\$7.00 4 - \$6.50

CUSTOM WOODEN SPOKE WHEELS

WHEEL STYLES

No. 1 Bolt Hub Wheel

PA Style has all steel hub with cast steel flange

For roller bearing axle.

1 1/4" Spokes with 1 1/4" Tires

*NOTE: This type of wheel is included in the price

No. 2 Sarven Hub Wheel

Old style hub with wood core

For plain type axle.

1 1/8" Spokes with 1" Tires

1 1/4" Spokes with 1 1/4" Tires

*NOTE: This type of wheel is included in the price

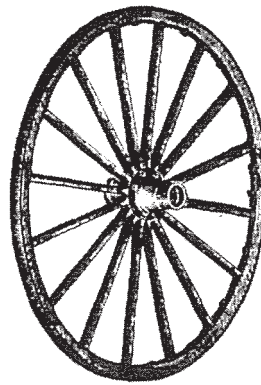
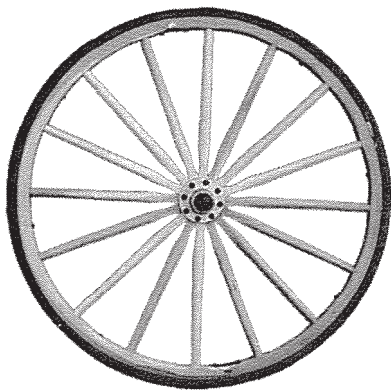

1" Plain Type Axle



No. 1 Bolt Hub Wheel, for 1" or 1 1/8" roller bearing axle.

Available in 24" - 44" diameter over wood rim, in even number sizes.

No. 9	Wheel with 1 1/8" half round cushion tire steel.....	\$190.00 ea.
No. 10	Wheel with 1" flat steel.....	\$110.00 ea.
No. 11	Wheel with 1 1/8" flat steel	\$116.00 ea.
No. 12	Wheel with 1" half round steel.....	\$120.00 ea.
No. 13	Wheel with 1 1/8" half round steel	\$125.00 ea.
No. 14	Wheel with 1" round top rubber tire.....	\$130.00 ea.
No. 15	Wheel with 1" flat top rubber tire.....	\$133.00 ea.
No. 16	Wheel with 1 1/4" round top rubber tire	\$136.00 ea.
No. 17	Wheel with 1 1/4" flat top rubber tire	\$140.00 ea.
No. 18	Wheel with 1 1/2" flat top rubber tire	\$225.00 ea.
No. 19	Wheel with 1 1/8" cushion tire half round steel.....	\$180.00 ea.

Buggy Wheels
"Used"
Garden Display
\$48.00

No. 2 Sarven Hub Wheel has a wood core inside hub covered with metal flanges.

Almost any boxing can be installed, including customers.

Available in 24" - 44" diameter over wood rim, in even number sizes.

No. 18	Wheel with No. 2 Sarven Hub, 1" flat steel.....	\$110.00 ea.
No. 19	Wheel with No. 2 Sarven Hub, 1" half round steel	\$120.00 ea.
No. 20	Wheel with No. 2 Sarven Hub, 1" round rubber tire	\$138.00 ea.
No. 21	Wheel with No. 3 Hub, 1 1/4" round top rubber tire	\$141.00 ea.

For 46", 48" and 50" wheels add \$20.00 to each price. For 52" wheels add \$30.00 to each price.

To install boxing into Sarven Hub \$12.00 ea.

Wheel, painted black.....\$40.00 ea.

Wheel tire resets on wood

on rubber

Wheel rubber tire, installed.....\$42.00 ea.



Axle Roller Bearing 64", 68", or any length

1" axle and bearing	\$84.00 set	2 - \$82.00 set	axle only - \$42.00 ea.
1 1/8" axle and bearing	\$98.00 set	3 - \$88.00 set	axle only - \$45.00 ea.
1 1/4" axle and bearing	\$110.00 set		axle only - \$43.50 ea.
1 1/4" axle stub and bearing	\$28.00 ea.		axle stub only - \$16.00 ea.
1 1/2" axle and bearings	\$140.00 set		axle only - \$58.00 ea.
1 1/2" axle stub and bearings	\$31.00 ea.		axle stub only - \$20.00 ea.

Axle Cap Straight, Arched, or Dropped

Hickory, tell axle size, length, and spring size
 \$12.00 pair 2 pairs - \$10.00 pair
 4 pairs - \$9.50 pair

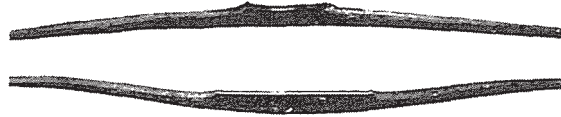

Axle Clip Stainless Steel Hex Nut

\$3.10 ea. 6 - \$2.80 ea. 12 - \$2.70 ea.

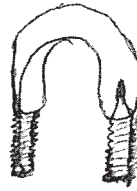

Axle Clip Prebend 5/16" Square Nut

2" to 7" in 1/2" steps
 \$1.40 ea. 25 - \$1.10 ea. 50 - \$1.00 ea.

Axle Bars for clips

5/16" by 5/8" steel. 1", 1 1/8", 1 1/4", 1 1/2" hole to hole
 \$0.40 ea. 25 - \$0.38 ea. 40 - \$0.34 ea.



Anti-Rattle Regular or Hoosier

\$3.70 ea. 10 - \$3.50 ea. 50 - \$2.25 ea. 100 - \$3.00 ea.



Regular



Hoosier

Coupler Plate for Anti-Rattler or Rubber Bushing Eye

\$5.25
 6 - \$5.00 ea. 2 Clip Mount
 10 - \$4.60 ea. Drilled Add 90¢
 20 - \$4.50 ea. NEW IMPROVED
 50 - \$4.00 ea. CASTING



Apron Buckles Plastic Side Release

Black. 3/4".
 \$0.28 ea. 30 - \$0.25 ea. 50 - \$0.22 ea.



Apron Splasher

30" x 32" shaft to axle \$22.00 ea.
 With 14" Drop, one piece and eyelets. \$30.00 2 pc. - \$28.00

Aluminum Bar Front Apron Bar

1/8" x 1/2", 12 feet. \$6.50 ea. \$0.70 per ft.

Battery Charger Output 12 volt, 4 amp

Works on 120 volt AC power. \$62.70 2 - \$54.00

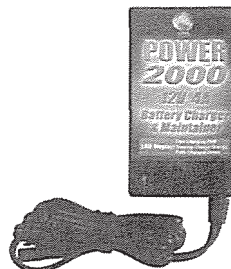

Axle Nut, Plain

5/8 - 11 Special sized, 5/8 - 12, 3/4 - 10,
 3/4 - 12, 11/16 - 11, 11/16 - 12, 7/8 - 9,
 7/8 - 10
 \$8.00 Up to \$19.00

Bearings Tapered Roller

#A6075 Bearings for 1" and 1½" axle	\$4.50 ea.			
#07093 Bearings for 1" axle	\$4.00 ea.		10 - \$2.50 ea.	
#7100 Bearings for 1½" axle	\$4.00 ea.		20 - \$2.00 ea.	
#07196 Cup Bearing Race	\$1.30 ea.		10 - \$1.00 ea.	
Mix and Match Bearings				
Ball bearings for wire spoke wheel 1½" o.d., ¾" shaft, sealed		\$3.60 ea.		4 - \$3.25 ea.

Bearings Axle Seal

1" axle and 1½" axle	\$1.35 ea.	10 - \$0.75 ea.	20 - \$0.70 ea.	40 - \$0.60 ea.
----------------------	------------	-----------------	-----------------	-----------------

Battery Deep cycle, 12 volt

\$74.00 ea.	\$10.00 less for old core
-------------	---------------------------

Battery 12 volt, 18 Amp hours

Sealed. 7" long x 3" wide x 6½" high. Rechargeable.

\$44.00 ea.	2 - \$40.00 ea.
-------------	-----------------

Body Hanger

¾" steel. 24" box. Legs 21.5" center. 5.5" drop. Tell 1¼" or 1½" spring size.

With plate on leg \$14.00 ea. 4 - \$12.00 ea.

Wider size of legs and different depth add - \$2.00 ea.



Brakes

Hydraulic 1", 1½", or 1¾" axle. 8" drum. Master cylinder and mount. Clamp on style.

\$348.00 ea.	2 - \$305.00 ea.	Taper Lock	24" Brake Line	\$4.20 ea.
10" Brake. 1¼" or 1½" axle.	\$400.00 ea.	Add \$42.00	30" Brake Line	\$4.40 ea.
Brake Shoe 8" Oh.	\$14.30 ea.		34" Brake Line	\$5.50 ea.
Park Valve	\$14.35 ea.		40" Brake Line	\$4.05 ea.
Piston 1"	\$5.40 ea.		Master Cylinder	\$45.00 ea.
Brake Drum 8"	\$28.00 ea.		Master Cylinder Kit	\$20.50 ea.
Wheel Cylinder - Steel	\$16.80 ea.		Wheel Cylinder Kit	\$4.60 ea.
Wheel Cylinder - Aluminum	\$32.00 ea.		Brake Fluid	\$3.00 ea. 2-\$2.80 ea.
#803 Master Cyl. Bracket	\$11.50 ea.		3/16 Tubing	\$1.45 / ft. 10 ft. \$1.35
#801 Foot Pad	\$5.30 ea.		Backer Plate	\$16.80 ea.
#802 Pedal Arm	\$18.00 ea.		Backer Clamp Mount	\$13.05 ea.
#63 Pedal Spring	\$1.85 ea.		Bleeder Screw	\$.50 ea.
#807 Stainless Knuckle	\$11.00 ea.		Shoe Hold Down Pin & Cup	\$0.50 ea.
Knuckle Rod Only	\$3.65 ea.		Brake Tube ¾" Coil	\$1.45 ft. 10 ft. - \$1.35 ft.
#809 Knuckle and Rod	\$12.50		Top Shoe Spring	\$1.15 ea.
Shoulder Bolt Stainless	\$6.10		Bottom Shoe Spring	\$1.45 ea.
Hose and Tee Fitting	\$21.00		Brass Adapter	\$2.50 ea.
Brass Tee and Bracket	\$4.90		Brake Hose	\$11.00 ea. 2-\$9.80
Hose Lock	\$1.75		Brass Tube Nut	\$.65 ea.

Buttons Covered Wire Eye

#30 ¾"	\$0.35 ea.	40 - \$0.30 ea.
#22 ¾"		

Buttons Black Paint

2" Prong	\$0.80 ea.	40 - \$0.75 ea.
----------	------------	-----------------

Coupler Shaft

Shaft Clip 2½" L

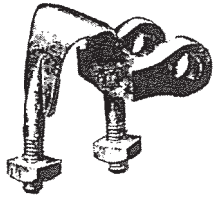

\$14.50 ea.

4 - \$13.20 ea.

Carpet Black Rubber Ribbed

Heavy Weight ½" Thick

24" - \$4.90 ft.

36" - \$6.00 ft.

10 ft. - \$4.50 ft.

10 ft. - \$5.50 ft.



6 Bells on a Strap

Bells Sleigh bells on leather strap with end buckles.

6 bells on strap stamped \$7.20 ea.

12 bell strap stamped \$13.20 ea.

30 bell strap stamped \$28.50 ea.

15 piece bell strap, heavy cast \$97.50 ea.

23 piece bell strap, heavy cast \$132.00 ea.

15 Piece Bell Strap

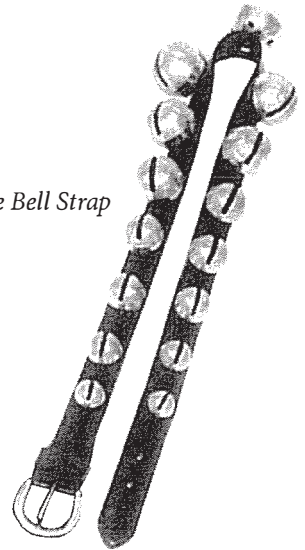

Bells 5 Shaft Bell, Graduated

\$49.90 ea.

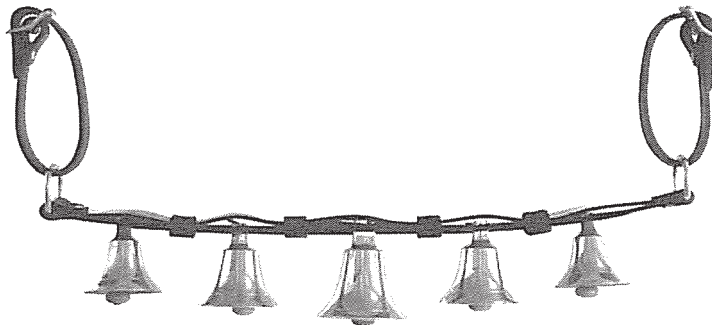

Wire: For Lighting

16 ga. primary.

100 ft. roll - \$12.80 ea.

2 spools - \$11.00 ea.

Clamp: Battery Connection

25 amp.

\$.75 ea.

4 - \$.70 ea.

Pony Wagon

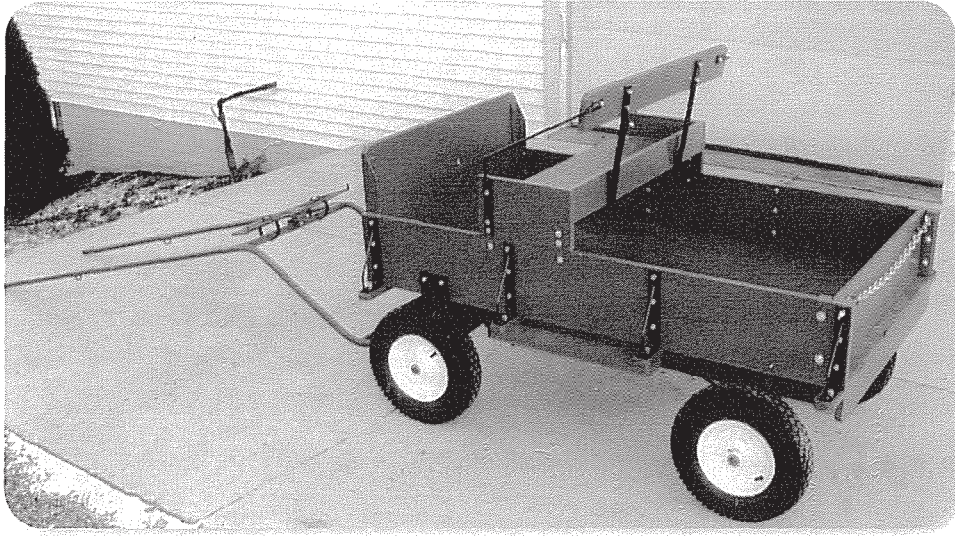

PONY WAGON

BODY: Bed size of 35" x 60". 1,200 lb. load capacity. Weighs 178 lb.

WHEELS: $\frac{3}{4}$ " ball bearing and 16" pneumatic tires.

AXLE: Fifth wheel steering.

SPRING: Elliptical leaf spring.

PRICE: \$570.00

OPTIONS:

Band Brakes \$115.00

Coil Springs \$85.00

Extra Seat \$86.00

Goat/Dog Wagon

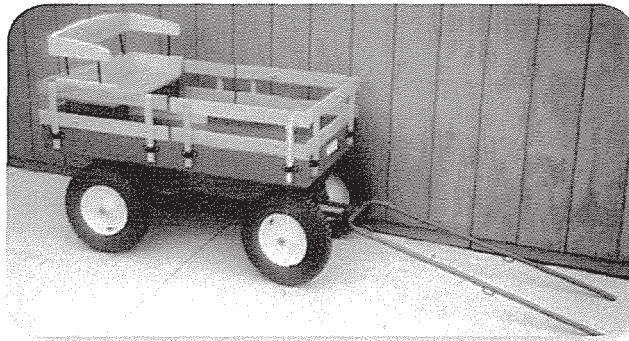

GOAT/DOG WAGON

BODY: Bed size of 25" x 48". 1,000 lb. load capacity. Weighs 90 lb.

WHEELS: $\frac{5}{8}$ " ball bearing and 16" pneumatic tires.

AXLE: Auto turn steering

PRICE: \$360.00

Block Brake

Lever Style	\$60.00 ea.	2 - \$56.00 ea.
Pedal Style	\$52.00 ea.	2 - \$48.00 ea.
Pedal Style, locking pedal	\$68.00 ea.	

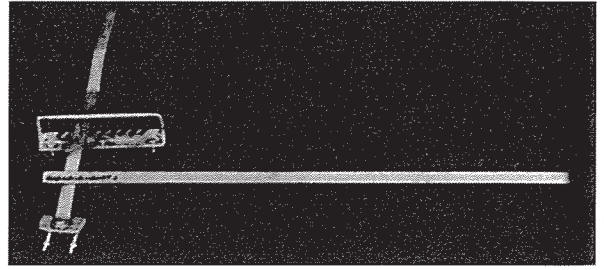

Cart Seat Bracket Folding

\$31.00 pair	4 pairs - \$29.00 pair
	8 pairs - \$28.60 pair



Curtain Tape

Velcro Hook & Loop, sew-on, 1". Black	\$0.60 /yard	25 yards - \$0.40 /yard
Adhesive back. 1". Black.	\$0.90 /yard	25 yards - \$0.70 /yard



Blanket

Woven Acrylic Fringed. 50" x 60". Plaid. Burgundy, Green-black, or Blue-green colors.
\$18.00 ea.

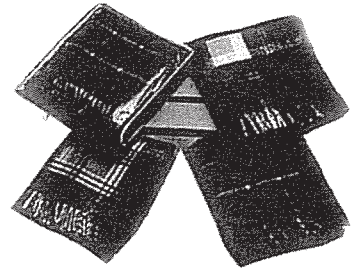

Buggy Robe

58" x 72". Black underneath. Fake fur, gray, brown, navy blue, dark green, burgundy, red.
\$49.00 ea. 2 - \$46.00 ea.

Curtain Lite

5" x 8" Cleat mount.
\$16.00 ea. 4 - \$15.80 ea.



Curtain Lite

Blankets

Cup Holder

Plastic. Collapsible. Dash mount.
\$7.25 ea. 2 - \$6.50 ea.

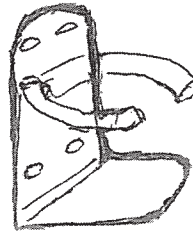

Cupholder

Emblem Plastic Back

Reflector Border	\$7.95 ea.	3 - \$7.00 ea.	6 - \$6.60 ea.
Reflective Tape Border	\$8.60 ea.	3 - \$8.00 ea.	6 - \$7.15 ea.
-black back			
Emblem Bracket	Swing a Way		
\$4.60 ea.	4 - \$4.00 ea.	8 - \$3.60 ea.	
Emblem Spade	\$1.75 ea.	5 - \$1.35 ea.	
Emblem Socket	\$1.35 ea.	5 - \$0.90 ea.	

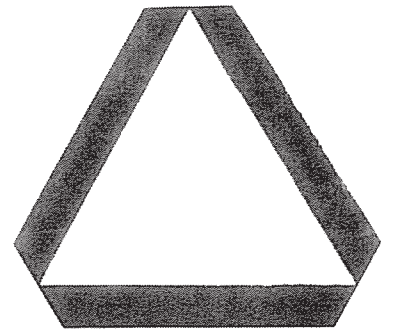

Emblem

Emblem Small size 8"

\$5.65 ea. 3 - \$5.00 ea.

Emblem Fiberglass Tough Back

\$7.00 ea.

Emblem Decal

\$5.00 ea. 3 - \$4.80 ea.

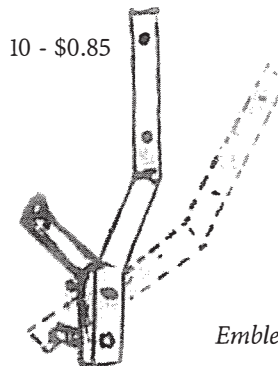

Emblem Bracket

Emblem Flag

Reflective Bands on Pole, 4 ft. long \$20.00 ea. 3 - \$18.00 ea.

FIFTH WHEEL WAGON BUGGY

Wagon Gear Fifth Wheel

#70-7 3/8" x 24" circle diameter
 Side spring mounts, 38" apart, inside.
 Supplied with two 38" long box bolsters.
 Distance between shaft eye is 39".
 Suited for light passenger and delivery wagons.
 For drop pole and shafts only.
 Plain circle with cross in center, and center bearing
 so load isn't on bolt. Shaft eye inside distance is 39".

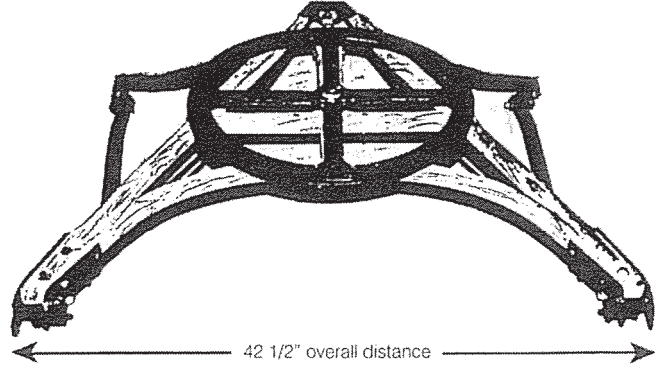

Front Platform only, less springs \$490.00 ea.

#70-8 1 1/2" x 4 leaf 38" side spring \$38.40 ea.
 Platform wagon springs only

#70-9 1 1/2" x 5 leaf 42" cross spring \$40.80 ea.
 Platform wagon springs only

Fifth Wheel Bow \$40.00 ea. 2 - \$38.00 ea.
 Fifth Wheel Circle - 24" \$55.00 ea.
 Center Load Bushing \$18.00 ea.

Spring Barrel Shackles

1 1/4" x 1 1/4" or 1 1/2" x 1 1/2". 3/8" bolts with four links.
 \$11.00 ea. 4 - \$10.00
 Links only \$0.85 ea.

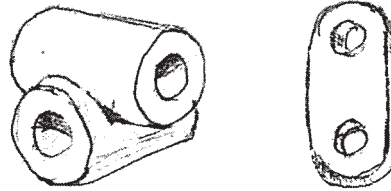

Light Buggy Double Reach

Fits 1" Angle Iron Reach.
 \$56.40 ea. 2 - \$49.00 ea.

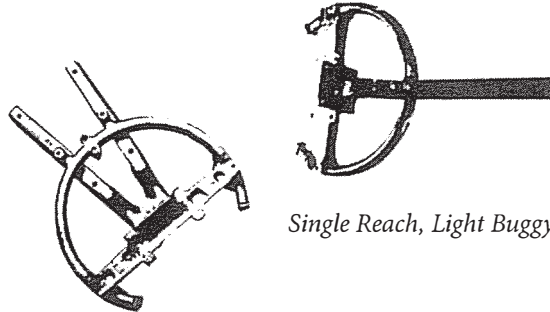

Light Buggy Single Reach

Fits 1 1/2" Channel Iron Reach
 \$50.40 ea. 2 - \$48.00 ea.

Single Reach, Light Buggy

Heavy Buggy Double Reach

Fits 1" Square Tube Reach. Short Turn.
 \$73.00 ea. 2 - \$69.00 ea.
 Bottom TEE Plate \$6.60 ea.

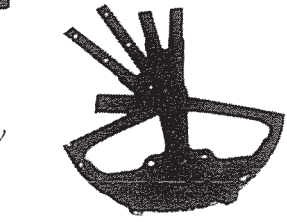

Double Reach, Heavy Buggy

Double Reach, Light Buggy

Welded Steel, Short Turn

\$135.00 ea. 2 - \$120.00 ea.

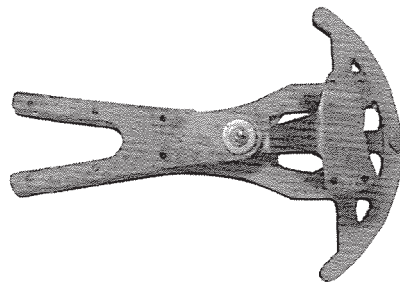

Buggy Jack Steel

\$27.50 ea. 2 - \$23.00 ea.

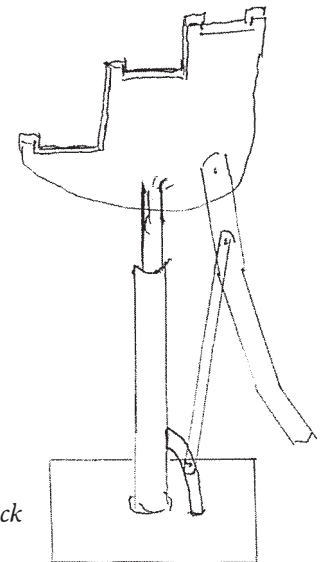

Buggy Jack

PAINTS

Urethane Coatings & Primers

Black Primer 6-1	\$52.00 gal.	2 - \$49.00 gal.
Black Gloss Paint 3-1	\$68.00 gal.	2 - \$60.00 gal.
Clear Coat Natural Finish 3-1	\$70.00 gal.	
Catalyst, Activator	\$75.00 gal.	2 - \$68.00 gal.
Reducer, Thinner	\$45.00 gal.	
Black, Air Dry	\$12.00 ea.	\$32.20 gal.

UPHOLSTERY - TOPPING & CURTAIN FABRICS

Garment Upholstery Leather, Black, 3.4 oz.	\$4.90 sq. ft.		10 - \$4.40 sq. ft.
Patent Leather "Imitation" Gloss Black, 55"	\$30.00 yd.	5 - \$27.25 yd.	10 - \$26.00 yd.
Sierra Brown Vinyl, 54"	\$10.25 yd.	5 - \$9.50 yd.	
Oxen 54" Black, Dark Gray, Dark Green, Dark Wine	\$10.00 yd.	5 - \$9.00 yd.	10 - 8.60 yd.
TV Curtain Fabric 60" Black, Lite weight	\$12.00 yd.	5 - \$10.00 yd.	10 - \$8.00 yd.
Canvas 50" White, Heavy weight	\$6.00 yd.		10 - 5.50 yd.
Duck Curtain Fabric 60" Black	\$23.00 yd.	5 - \$21.00 yd.	

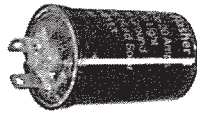

Foam Spray

16 oz. Aerosol.
\$7.00 ea. 2 - \$6.50 ea.

Flasher LED Lighting

12 Volt. 1-20 amp. Grounded.
\$9.55 ea. 2 - \$9.00 ea. 3 - \$8.25 ea.

Flasher LED Red or Amber

Magnetic Base. 4" x 6". Uses 4 AA batteries. Steady or flashing mode.
Red \$33.00 ea. 2 - \$28.90 ea.
Amber \$22.00 ea. 2 - \$20.00 ea.
Mounting Bracket, metal \$7.20 ea.

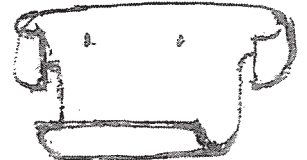
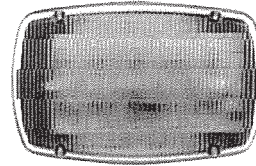

Axle Washer Leather Coil

\$3.80 4 - \$3.50

Axle Wrench 1" square

\$14.00

Hub Cap EZ Pin Style

\$3.70

26
MIRRORS

Black Plastic Mirror

Rigid Steel Bracket. No. M40.
\$15.00 ea. 10 - \$11.00 ea. Case of 24 - \$9.50 ea.

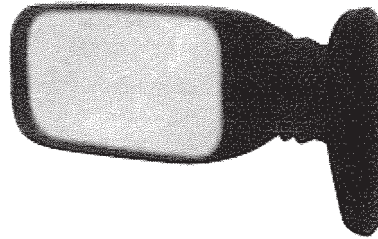

Lighted Mirror

Blue, Green, Amber, and Clear colored bulbs.
12 Volt. Black plastic.
\$14.00 ea. 4 - \$12.00 ea. 8 - \$11.00 ea.

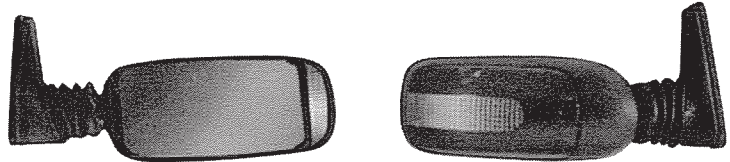

Lighted Mirror—LED Amber

Steel Bracket.
\$16.00 ea. 6 - \$15.50 ea. 10 - \$14.50 ea.

Round Black Mirror

5" Diameter. Flat Glass.
\$7.00 ea. 4 - \$6.00 ea. 10 - \$5.50 ea.

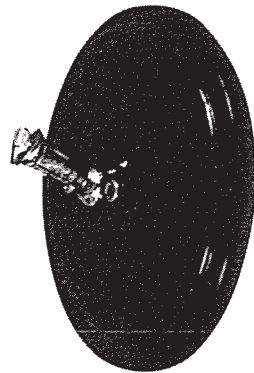

Round Chrome Auto Style

4 3/4" Diameter. \$8.00 ea.
With Chrome Buggy Bracket \$15.00 ea.



Oblong Chrome Auto Syle

5" x 4" Oblong. \$8.00 ea.
With Chrome Buggy Bracket \$15.00 ea. 4 - \$12.00 ea. 6 - \$11.50 ea.

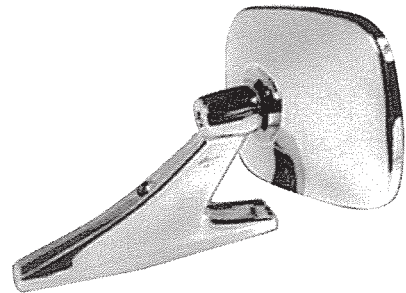

Brass Top Nut

7/16" Thread. Polished.
\$4.40 ea. 8 - \$4.20 ea. 12 - \$3.90 ea.



Easy Entry Cart

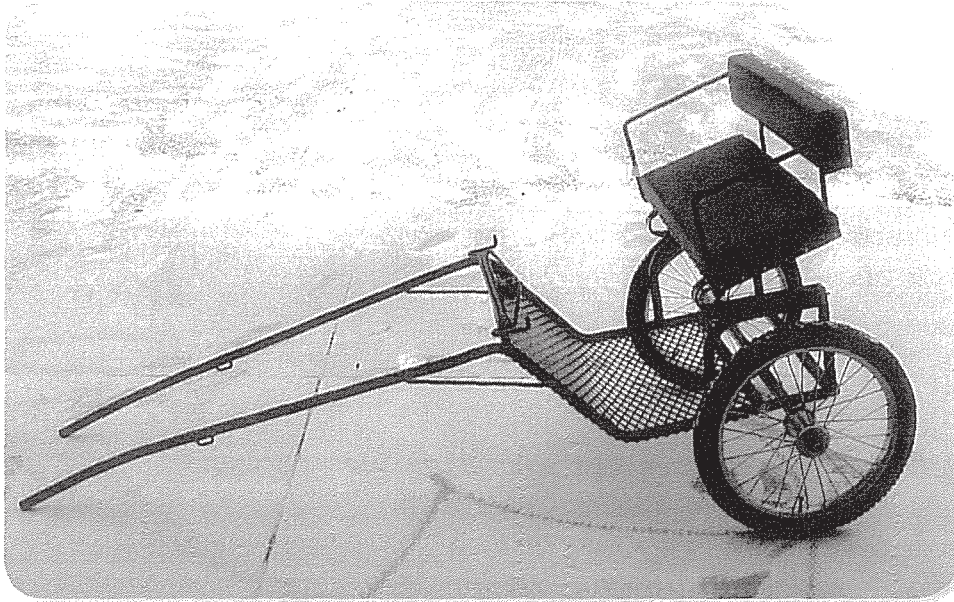

EASY ENTRY CART

BODY: Steel construction.

MINIATURE HORSE SIZE: \$430.00 ea.

PONY SIZE: \$450.00 ea.

HORSE SIZE: \$490.00 ea.

Pony Cart Flag

70", mount plate.
\$7.20 ea.



CUT UNDER SURREY

BODY: 28" x 72" with 40" wide seat. Patent leather padded dash.
Brass reign rail.

WHEEL: 36" x 44" rubber tire .

AXLE: 1 1/8" roller bearing.

BRAKE: Hydraulic.

SHAFTS: Steam bend horse.

PAINT: Black automotive.

UPHOLSTERY: Button tufted seat.

PRICE: \$3,840.00

OPTIONS:

Pole in place of shaft \$235.00

Patent padded fenders \$290.00

12 Volt Lamps \$380.00

Pinstriping \$288.00

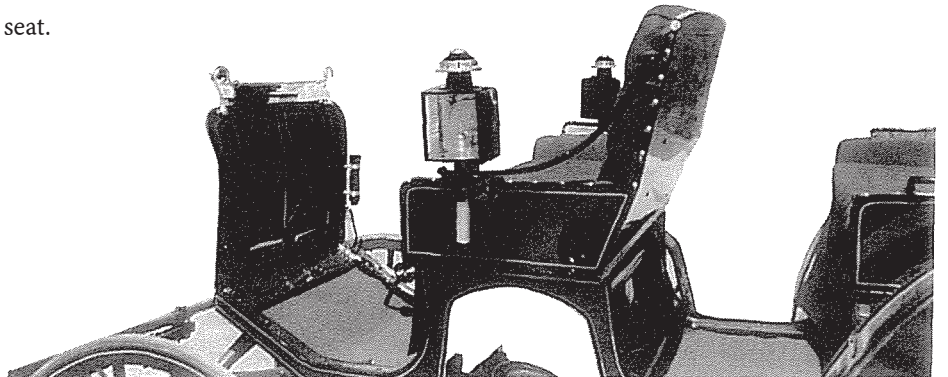
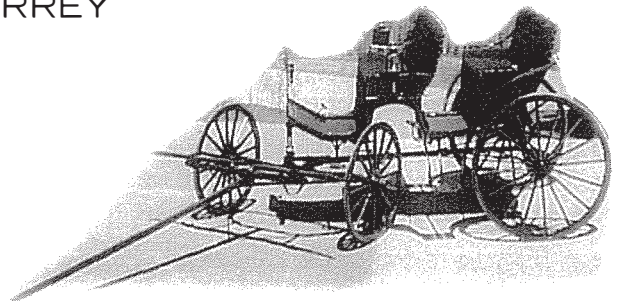

DASHES—Fabricated & Sew Covered

Soft Leather Covered

Style #10 Plain Flat—14" Height. Overall Length below.

22" - \$47.50 ea. 24" - \$51.50 ea. 26" - \$55.70 ea. 28" - \$60.00 ea.

Style #10 Plain Flat—16" Height. Overall Length below.

22" - \$54.00 ea. 24" - \$58.80 ea. 26" - \$64.00 ea. 28" - \$81.00 ea.

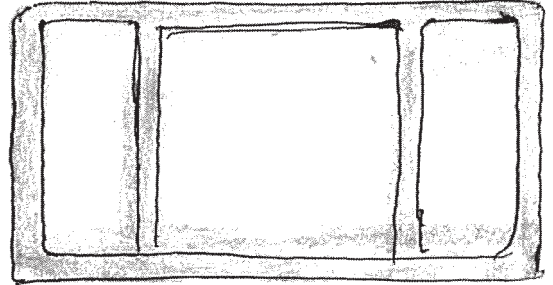

Style #12 Flat Dash—14" Height. Hand holds. Lip at Bottom.

22" - \$53.00 ea. 24" - \$58.50 ea. 26" - \$63.25 ea. 28" - \$68.25 ea. 30" - \$73.00 ea.

Style #12 Flat Dash—16" Height. Hand holds. Lip at Bottom.

22" - \$61.25 ea. 24" - \$66.75 ea. 26" - \$72.25 ea. 28" - \$78.00 ea. 30" - \$83.50 ea.

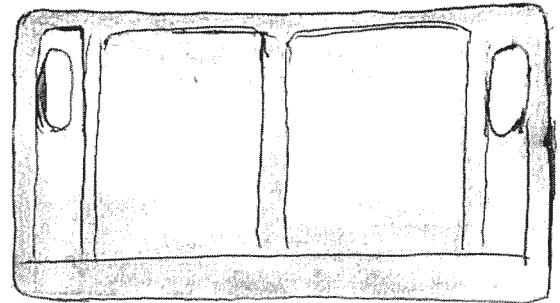

Glossy Imitation Patent Covered

Style #30 Curved Dash—16" Height. Fancy. Hand holds. Bottom Lip.

24" - \$69.50 ea. 26" - \$75.10 ea. 28" - \$81.10 ea. 30" - \$86.85 ea. 34" - \$98.25 ea.

Wheel Fenders—6" x 60". Black Patent - \$90.00 ea
Wood Bend - \$34.00 ea.

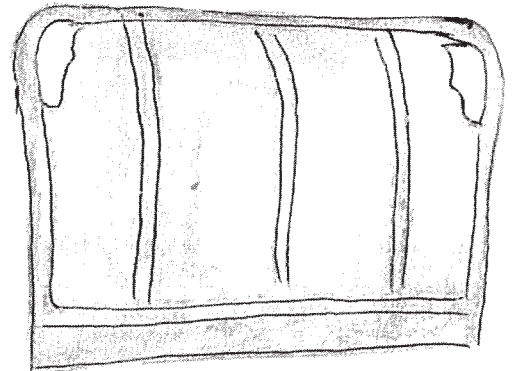

Rein Rail

Steel. Painted. Acorn Nut Bolt On.

\$14.25 ea. 2 - \$12.50 ea.

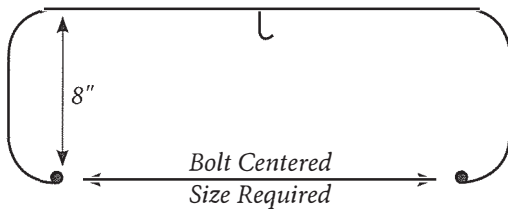

Fiberglass Seats

36" wide	\$140.00 ea.	W - \$132.00
42" wide	\$160.00 ea.	W - \$150.00
45" wide	\$160.00 ea.	W - \$152.00

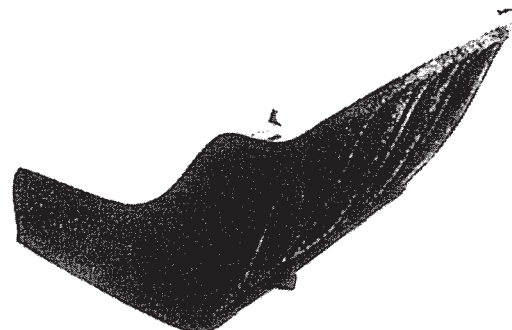

Bees Wax, Sewing Machine

Thread wax - .5 oz. Blocks

\$3.00 ea.

Rub Iron—Angled Buggy Size

1" x 4" Roller. Nylon Bushing.
 \$8.60 ea. 4 - \$7.80 ea. 10 - \$7.00 ea.

Rub Iron—Cast Ductile Iron

5/8" Steel Roller on Stainless Pin.
 \$6.00 ea. 4 - \$5.80 6 - \$5.60 ea.
 10 - \$5.45 ea.

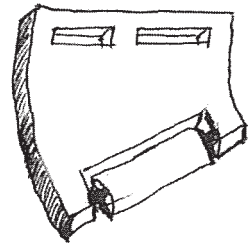
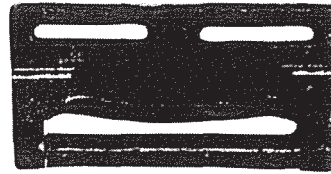

Rub Iron—Fabricated Steel

1" x 4" Roller. Nylon Bushing.
 \$6.00 ea. 4 - \$5.80 ea. 10 - 5.50 ea.

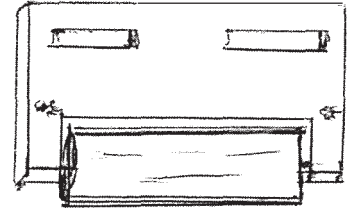

Reach—1" Angle Iron

Wood Double Clip. 60" long.
 \$14.40 ea. 6 - \$12.00 ea.

Reach—1" Square Tube

Double Clip. 60" long.
 \$14.50 ea. 4 - \$13.00 ea.

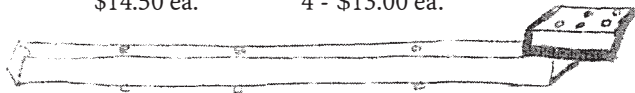

Reach End Heels

8" long. Double Clip. Fits 1" square tube.
 \$8.40 ea. 4 - \$8.00 ea.

Reflective Tape

Adhesive Back. Diamond Silver. 1" wide roll.
 \$0.80 /ft. 100 ft. roll - \$65.00 /roll
 Mounted on 1" by 36" metal
 \$3.00 ea. 25 - \$2.50 ea.

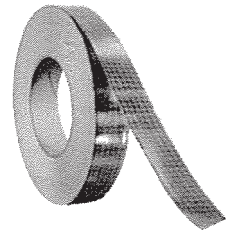

Switch—Rocker Style

LED illuminated red, green, or blue color.
 \$3.50 ea. 6 - \$3.30 ea. 12 - \$3.00 ea.

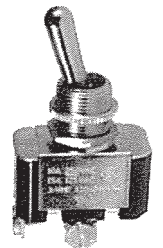
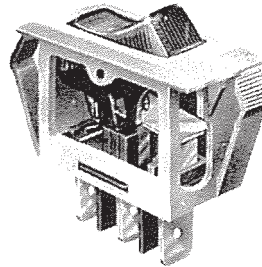

Reach Brace

5/8" round. 33" long. Drilled for 1" axle.
 3/4" square at axle 6 - \$4.70 ea. \$5.00 ea.

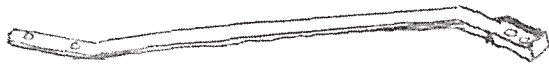

Toggle Switch—2-way, off-on

\$3.25 ea. 3 - \$3.00 ea.

Rein Rail—Brass Polished Specify Length.

20" - 36". Even numbered sizes only. \$56.70 ea. 2 - \$50.40 ea.
 Brass Center Post \$9.20 ea. 2 - \$8.00 ea.
 Chrome Polished \$68.00 ea. 2 - \$65.00 ea.



Toggle Switch—3-way, on-off-on

\$4.60 ea. 3 - \$4.00 ea. 6 - \$3.75 ea.

Switch—Push-Pull

\$2.50 ea. 3 - \$2.30 ea. 6 - \$2.00 ea.

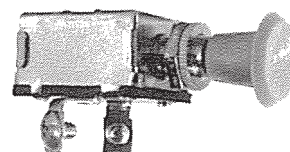

Rope, Nech Tie, Poly Blach

Green, Blue.
 \$14.10 ea. 3 - \$12.00

Open Buggy—Single Seat Runabout

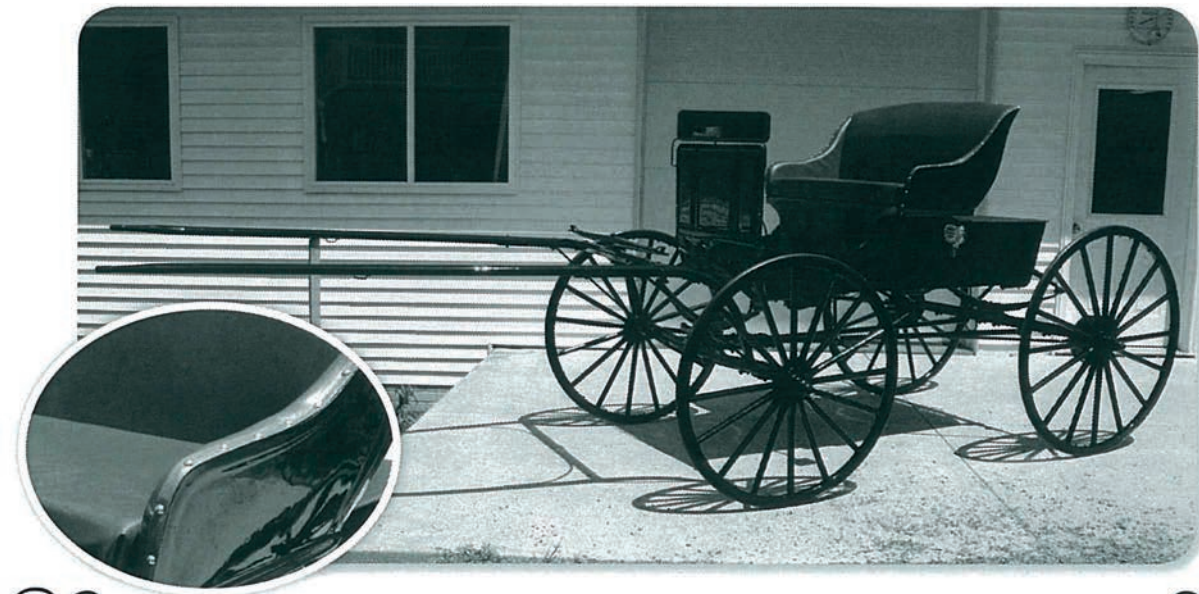

OPEN BUGGY—SINGLE SEAT RUNABOUT

BODY: Hickory framed, plywood panel, 26" wide x 64" long. Hardwood seat, glued, screwed, well braced.
Fiberglass seat measures 42" wide at top side panels.

WHEELS: Bolted hub style, $1\frac{5}{16}$ " rim on $1\frac{1}{8}$ " half round tires.

AXLES: 1" x 58" track, short turn fifth wheel. Square tubing reaches.

BRAKES: Hydraulic 8" rear wheels.

SHAFTS: Steam bent hickory, well ironed and braced. Sword single tree.

UPHOLSTERY: Vinyl in your choice of color.

PAINTING: Urethane, gloss black.

LIGHTS: Double face, with turn signal, strobe flasher on box, 12 volt battery. SMV emblem.

PRICE: \$3,050.00

OPTION: Pinstriping \$240.00
Cushion Tires \$200.00

Second seat, removable - add \$320.00



SINGLE TREES

Sword End Single Tree

20" - 42". Even numbered sizes only
 \$5.75 ea. 4 - \$4.80 ea. 6 - \$4.50

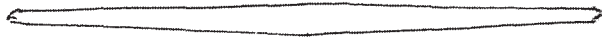

Single Tree Hook

Fits onto Sword End \$10.20 ea.
 Leather or Chain Trace 4 pieces - \$9.00 ea.

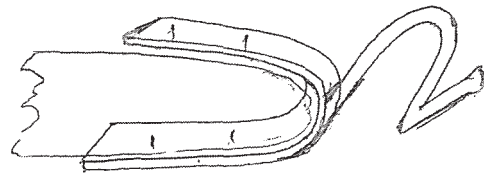

Round End Single Tree Blank

1 1/2" x 2". 28" - 38". Even numbered sizes only.
 \$5.75 ea. 4 - \$4.80 ea. 6 - \$4.50 ea.



SHAFTS

60" or 65" Pony Buggy w/Bar	\$40.20 /pair	3 pairs - \$95.00
48" or 50" Mini Horse Buggy w/Bar	\$47.20 /pair	3 pairs - \$113.15
1 3/8" x 1 7/8" Horse Buggy w/Bar	\$42.20 /pair	6 pairs - \$215.00
1 1/2" x 2" Horse Buggy w/Bar	1 side only \$20.00	6 pairs - \$215.00
1 1/2" x 2" Draft Horse w/Bar	\$36.00 /pair	3 pairs - \$116.95
1 15/16" x 2 1/2" 12 ft. Straight Heel Cart Shaft		\$59.00 / pair
1 3/4" x 2 1/4" 11 ft. 6" Straight Cart	\$63.60 /pair	3 pairs - \$142.00
1 3/8" x 1 7/8" 96" Straight Mini Cart	\$43.60 /pair	3 pairs - \$101.75
1 3/8" x 1 7/8" Dble. Mini Cart	\$90.00 /pair	3 pairs - \$215.00
1 1/2" x 2" Dble. Horse Buggy w/Bar	\$42.60 /pair	3 pairs - \$108.00
1 15/16" x 2 1/2" Dble. Horse Pole	\$44.10 ea.	3 pairs - \$40.00 ea.
1 3/8" x 1 7/8" 10 ft. Straight Pony Cart	\$54.00 / pair	2 pairs - \$40.00 / pair

Jog Cart Shaft .

Quick Hitch.
 \$160.00 pair 3 pair - \$145.00

Jog Cant Shaft

Long style, drop heel, regular hitch.
 \$135.00 pair 3 pair - \$120.00
 1 side only - \$65.50 ea.

1 3/4" x 2 1/2" x 130" Single Horse Pole	\$42.00 ea.	3 - \$39.00 ea.
1 3/8" x 1 5/8" x 100" Double Bend Pony Cart, 30" heel	\$125.00 / pair	2 pairs - \$108.00 / pair
1 1/2" x 2" x 11 ft. Double Bend Horse Cart, 32" heel	\$93.70 / pair	2 pairs - \$77.60 / pair
1 3/4" x 2 1/4" x 11 ft. Double Bend Horse Cart, 32" heel	\$96.00 / pair	2 pairs - \$79.00 / pair
1 3/4" x 2 1/4" x 12'6" Double Bend Horse Cart, 32" heel	\$110.00 / pair	2 pairs - \$100.00 / pair

Spring Buggy Shafts

1 1/4" 4-leaf 30"	\$46.00 ea.
1 1/4" 3-leaf 36"	\$49.00 ea.
1 1/4" 4-leaf 36"	\$56.40 ea.
1 1/4" 5-leaf 36"	\$58.80 ea.
1 1/2" 4-leaf 36"	\$64.80 ea.
1 1/2" 5-leaf 36"	\$67.20 ea.
1 1/2" 6-leaf 36"	\$110.00 ea.
1 1/2" 5-leaf 30"	\$80.00 ea.

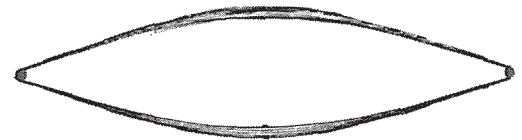

Pole Bow

Spring Liner, Plastic \$50 per ft. - 20 ft. - \$42

Shaft Hold-Up To hitch horse.

Neck Yoke Horse	\$13.60 ea.	3 - \$11.30 ea.	\$4.80 ea.
Double Tree Horse	\$12.00 ea.	3 - \$10.60 ea.	2 - \$4.50 ea.
Pole Bow Horse	\$12.80 ea.	3 - \$11.00 ea.	
Cart Circle Bar	\$13.50 ea.	3 - \$12.00 ea.	
Buggy Circle Bar	\$7.80 ea.	3 - \$6.50 ea.	

Bio Strap Pole to bow. Stainless Hardware.

\$8.00 ea. 4 - \$7.50 ea.



Tug Stop

3" Brass	\$24.00 /pair	5 pairs - \$22.90	10 pairs - \$21.60
3" Chrome	\$28.00 /pair		

Shaft Extender Forged tube.

Fits on buggy shaft. Add 6" to shaft length.
 \$28.00 pair 2 - \$26.00 pair

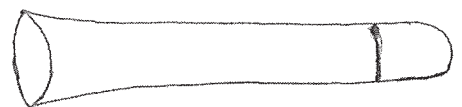

Three Spring Wagon

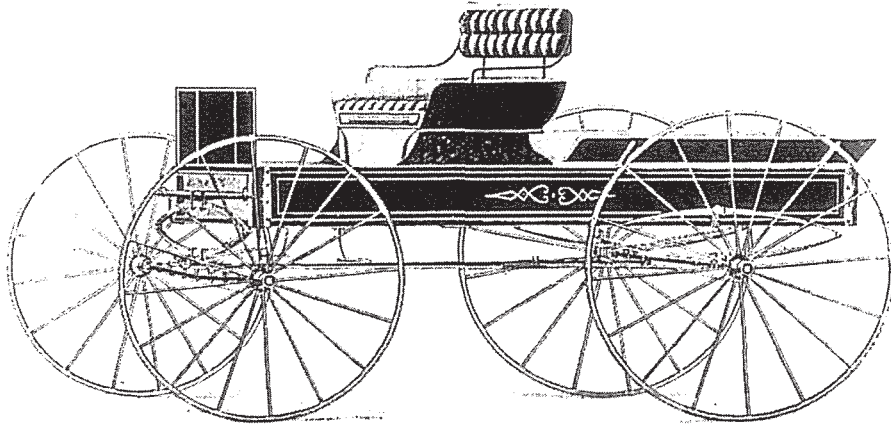

THREE SPRING WAGON

BODY: Thoroughly substantial, 7' long, 33" wide, 8" panels. Floor boards, leather dash, drop end gate. Seat measures 38" across top of seat panels.

WHEELS: Bolted hub, fitted with 1" half round steel or rubber tire.

SPRINGS: Alloy steel; 1¼", 4-leaf x 36" in front; two 1½", 3-leaf x 36" inch in back.

AXLES: 1½" x 64" bearing type. Short turn fifth wheel, steel tube reach, well ironed and braced.

BRAKES: Hydraulic 8" Ohio style, rear wheels.

SHAFTS: Hickory, well ironed and braced, sword single tree.

UPHOLSTERY: Seviceable vinyl, foam cushions, 8" lazyback.

PAINTING: Gloss black Alkyd automotive enamel.

PRICE: \$3,300.00

OPTION: Pinstriping \$240.00

Wagon Seat—Wooden

Poplar wood with back board. 36", 40", or 45" wide sizes.
 \$105.00 ea. 3 - \$92.00 ea.

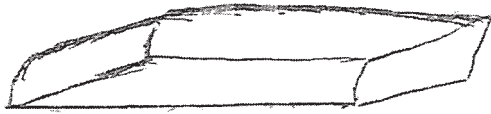

Wagon Seat Bench

No Paint \$260.00 ea.
 With Black Paint \$340.00 ea.
 With Clear Finish \$328.00 ea.



Seat Spring

1 1/4" x 24" 2-leaf \$36.75 ea.
 1 1/2" x 24" 2-leaf \$40.00 ea.
 1" x 12" 1 leaf \$20.00 ea.

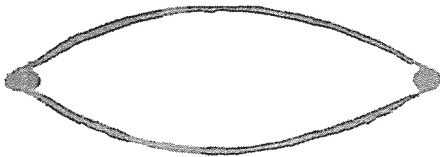

Ornamental Seat Spring

1 1/2" x 18"
 \$22.00 ea. 4 - \$20.00 ea.

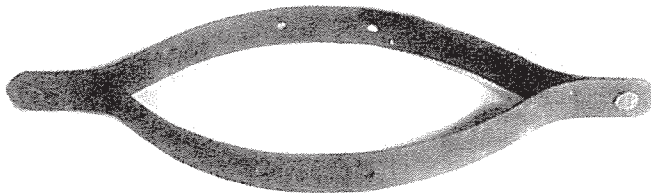

V-Bend Cart Seat Spring

1 1/2" Spring Steel, Oil Tempered.
 \$14.00 ea. 4 - \$12.00 ea.

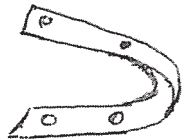

Shaft Leather Kit

Black imitation leather and bio straps.
 \$11.00 ea. 3 - \$10.50 ea.



Shaft Repair End

Black paint.
 \$8.50 ea. 6 - \$7.40 ea.



Signs

Caution Sign \$11.50 ea. 3 - \$10.00 ea.
 Whoa Sign \$11.50 ea. 3 - \$10.00 ea.
 License Sign \$6.25 ea. 3 - \$6.05 ea.

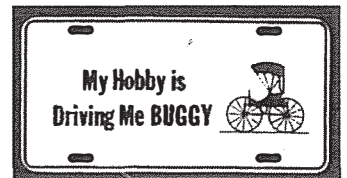

Spring Bar—Blunt End

Hickory. 1¼" or 1½" spring. 22" - 34" even sizes. Specify size.
 \$7.20 ea. 4 - \$6.00 ea.

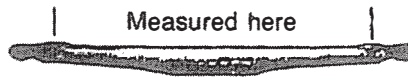

Spring Bar - Fancy End

\$15.00 ea. 4 - \$13.75 ea.



Single Tree—Hook End

Hickory. 20" - 38" even sizes. Specify size.
 \$9.90 ea. 6 - \$9.70 ea.

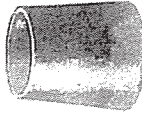

Single Tree Ferrul 7/8"

\$1.10 ea. 10 - \$0.90 ea.

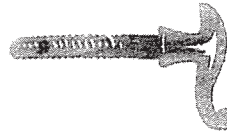

Single Tree Hook Brass

\$1.85 ea. 6 - \$1.55 ea. 12 - \$1.55 ea.

Shaft Tips

¾" or 7/8" Brass Polished		\$4.00 ea.
1" Brass Polished		\$4.50 ea.
1 1/8" Brass Polished		\$5.00 ea.
1 1/4" Brass Polished		\$5.50 ea.
10 or more mixed sizes		\$0.20 less ea.
7/8" Stainless Tip	\$1.50 ea.	10 - \$1.25 ea.
7/8" Steel Tip	\$1.20 ea.	10 - \$1.10 ea.

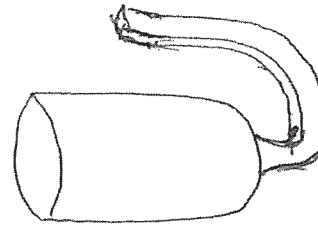
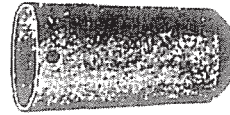

Single Tree Hook Steel

Fits round end single tree. Fits leather or chain traces.
 \$12.00 ea. 6 - \$10.00 ea.

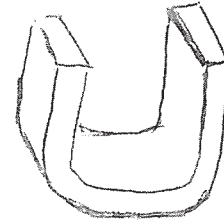

Shackle Clevis

For shaft coupler and spring clevis.
 1", 1¼", or 1½" size between legs.
 \$3.00 ea. 6 - \$2.50 ea.

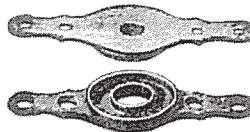

Single Tree Caster

2" wide. Steel.
 \$4.00 ea. 10 - \$3.80 ea.
 Heavy-flat style, 4" x 1¼".
 \$5.80 ea. 6 - \$5.00 ea.

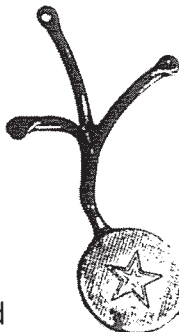

Welded Steel

4" x 4½" square dotted tread.
 \$13.50 ea. 4 - \$12.80 ea.



Step—Round Buggy Cast Iron

6½" drop, 4½" round.
 \$12.60 ea. 6 - \$11.20 ea.
 Dotted Thread

4½" Round Step Plate

\$3.85 6 - \$3.50

Step—Round Buggy Welded

\$12.75 4 - \$11.50

Double Buggy Step

Back Door Entry. 7" drop.
 \$35.00 ea. 3 - \$30.00 ea.

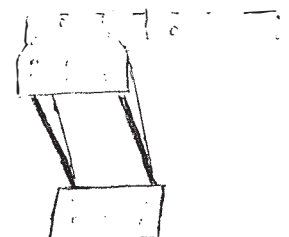

Complete Shaft

Horse Size—no paint
 Draft Size—no paint
 Painted add

\$170.00 ea.
 \$190.00 ea.
 \$65.00 ea.



Shaft Hitching Hook

\$4.80 6 - \$4.50 ea.

Shaft Kit

Preassembled and broken down to ship
 Horse Size
 Draft Size
 Draft Size Double Bend Heel

\$140.00 ea.
 \$160.00 ea.
 \$200.00 ea.



Shaft Loop 1 1/2" strap

Nickle Plate	\$0.35	10 - \$0.30	20 - \$0.25
Cast Brass Polished	\$1.30	6 - \$1.15	

Buggy Seat

Poplar wood. Full back. 16" bottom. Slatted lid.
 Small sizes, 36" or 38"
 40" or 44"
 *NOTE: Sizes are measured at front of bottom.

\$84.00 ea.
 \$90.00 ea.

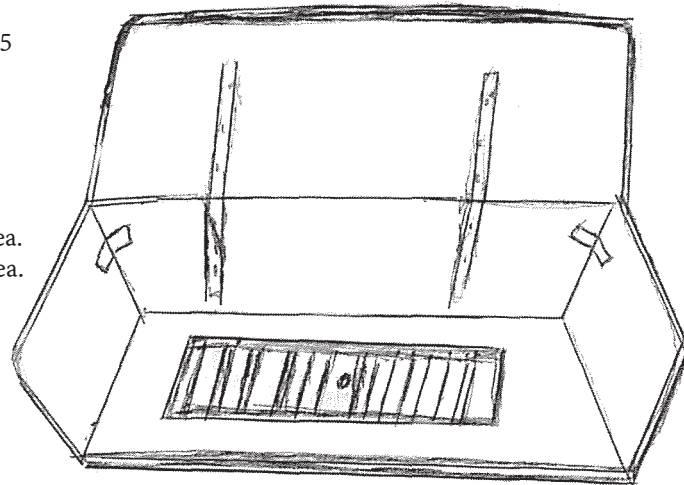

Seat, Jog Cart, High Cushion Blach.

\$98.00 2 - \$90.00

Shaft Heel Iron

1 1/4" steel. Holes punched.
 Solid Steel Eye
 Nylon Eye
 Bushing

\$12.50 ea.	4 - \$10.00 ea.
\$14.00 ea.	4 - \$12.00 ea.
\$1.30 ea.	10 - \$1.20 ea.

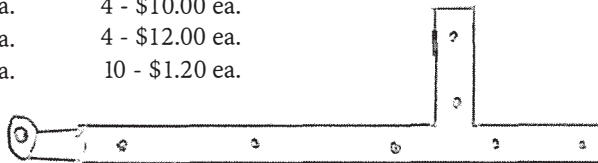

Trace Holder—Springie Packed with screws.

\$2.50 /pair 5 pairs - \$2.20 /pair 10 pairs - \$2.00 /pair



Trace Holder—Solid Brass Polished.

\$6.50 /pair 3 pairs - \$6.25 /pair 10 pairs - \$6.00 /pair



Trace Holder—Leather

1/2" x 6" with screws	\$1.40 /pair	10 pairs - \$1.35 /pair	20 pairs - \$1.30 /pair
Leather only	\$0.60 /pair		

Single Tree

Harness Trace



Steel Neck Yoke With Eyebolt

Available in 35", 38", 40", or 42" lengths
\$42.00 ea.



Wood Neck Yoke

Available in 34", 36", 38", 40", 42", 44", or 48" lengths.
\$46.80 ea.



Surrey Pole

Draft Size \$300.00 ea.
Horse Size \$280.00 ea.
Painted Add \$40

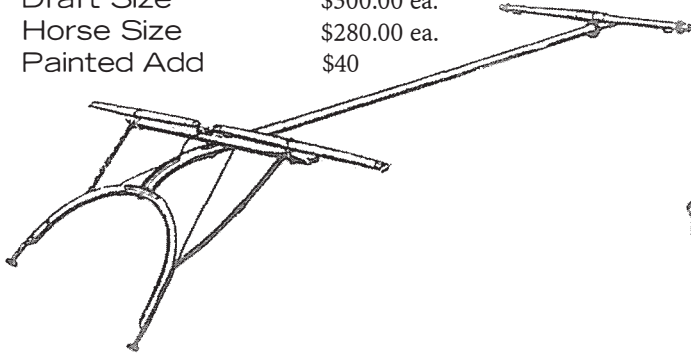

Wooden Double Tree with Single Tree & Hardware

Available in 40", 42", 44", 48", or 50" lengths.
\$76.80 ea.

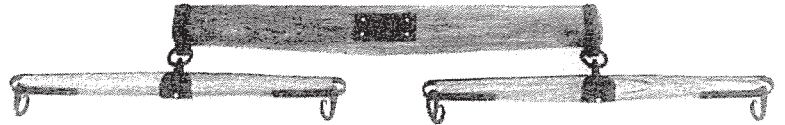

Pole Strap Bio Adjustable

\$8.70 ea. 4 - \$7.80 ea.

TONGUES

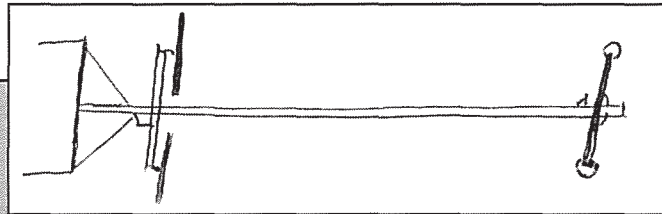

No. 2355

#2360

#2365

#5133

#8721

#9549

#8702

All Tongues are ash hardwood, tapered, planed, and chamfered.

2360 Wagon Tongue - 13' blank, unpainted	46#	\$45.60 ea.	
2365 Mower Tongue - 14' blank, unpainted	58#	\$50.40 ea.	
8264 Cart Tongue - 13' fitted and painted, no hardware (<i>not pictured</i>)	44#	\$50.40 ea.	
5133 Plow Tongue w/Neck yoke - fitted and painted, w/hardware	46#	\$192.00 ea.	
8721 Wagon Tongue - fitted and painted, w/hardware and adaptor	61#	\$154.00 ea.	
9549 Pony Wagon Tongue - fitted and painted, w/hardware	33#	\$176.80 ea.	
8702 Combination Wagon Tongue - steel, front part detaches when using tractor 88#		\$198.00 ea.	
2355 Pony Wagon Tongue - Steel neck yoke, double tree painted		\$240.00 ea.	Horse - \$260.00

LED LIGHTS

LED Tail Light Stainless Steel Flange.

\$18.00 ea. 4 - \$15.00 ea. 6 - \$14.00 ea.

LED Tail Light

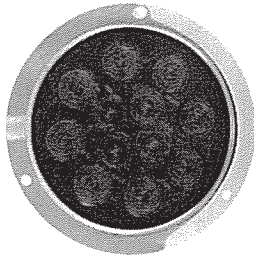

LED Dash Light

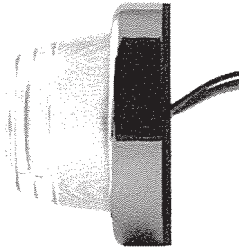

LED Dash Light Flat Surface Mount. Optic Lens.

Clear lens, 1 diode, 1 wire.
 \$20.00 ea. 4 - \$18.00 ea. 6 - \$16.80 ea.
 Clear lens, 1 diode, 2 wires.
 \$19.00 ea. 4 - \$16.00 ea. 6 - \$15.60 ea.
 Red lens, 1 diode, 1 wire.
 \$19.00 ea. 4 - \$16.00 ea. 6 - \$14.80 ea.
 Clear lens, amber diode.
 \$19.00 ea. 4 - \$16.00 ea.

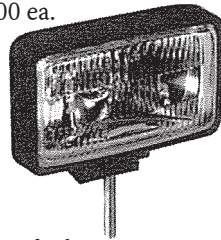

Plastic Headlights

Square LED Black Plastic.
 Double Beam LED Lamp Black.
 #20 3-1 Watt LED's. High .72 amp. Low .36 amp.
 \$65.00 ea. W - \$55.00 ea.
 #50 True Hi and Low Beam
 \$73.00 ea. 4 - \$68.00 ea.

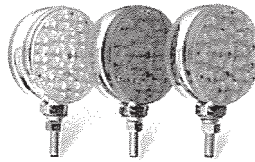

Double Face Lights

Red and Clear Lens 21 LED.
 Screw-In Lens, 2 wire
 \$54.00 ea. 4 - \$50.70 ea. 8 - \$48.40 ea.
 Snap-On Lens, 4 wire, turn signal
 \$51.00 ea. 4 - \$48.00 ea.

Incandescent Bulb
 \$15.60 ea.
 Dissembled Housing, No Bulb.
 \$8.00 ea. 4 - \$7.40 ea.

LED Insert for changing old 2-way to LED.
 Red and Clear with Optic Lens.
 \$18.00 ea. 4 - \$14.00 ea.

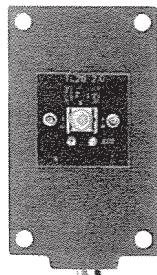

LED 12 Volt Bulb

Diodes, works in two-way lights.
 \$19.00 ea. 4 - \$17.80 ea.

Black Rubber Light

LED Bulbs
 \$56.00 ea.

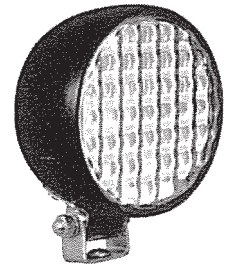

Chrome Housing Fitted LED Bulb Unit

\$68.00 ea.

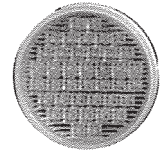

LED Sealed Light Bulb Unit

With wires. Fits metal housing.
 \$40.00 ea. 4 - \$38.00 ea. 6 - \$34.00 ea.

LED Pilot Light

5/16" Mounting Hole. Red.
 \$3.45 ea. 4 - \$3.30 ea. 6 - \$3.00 ea.



LED Marker Lamp

Chrome, clear lens \$9.45 ea.
 Black, clear lens \$9.45 ea.
 Chrome, amber lens \$7.45 ea.



LED Dome Light

Chrome-plated Plastic housing. 1 LED.
 \$16.80 ea. 2 - \$14.75 ea.

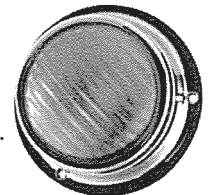

LED Strobe Flasher

4 LEDs. Steady or flashing modes. Aluminum body.
 \$28.25 ea. 2 - \$29.90 ea.



LED Strobe 3 Diode

Amber.
 \$35.00 ea. 2 - \$30.00 ea.

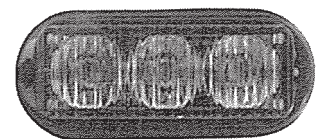

Bike Light with Strap

Red or Amber. AA battery.
 \$4.90 ea. 4 - \$4.70 ea. 12 - \$4.40 ea.

Fringe Gold, Black, Red, or White

Heavy Tassel 6". \$7.90 /yard 18 yards - \$7.00 ea.
 Lite Tassel 6". \$4.55 /yard 18 yards - \$4.00 ea.

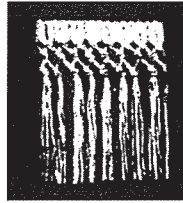

Horse Driving Harness

New \$430.00
 Used \$180.00

Hold Back Strap Bio, Stainless Hardware

Horse size \$19.00 /pair 3 pairs - \$17.60 /pair
 Leather Stainless Hardware \$19.20 /pair
 Pony Bio Stainless Hardware \$14.00 /pair

5 pairs - \$17.00 /pair



Hold Back Snap Stainless
 \$2.80 ea. 4 - \$2.40 ea.



Harness Parts

Saddle Turret Ring Stainless \$2.40 ea.
 Line Holder Mounts on hip strap. Chrome \$3.30 ea.
 Tug Extender Bio Hook or Snap. \$9.45 ea.

4 - \$8.20 ea.

6 - \$7.90 ea.

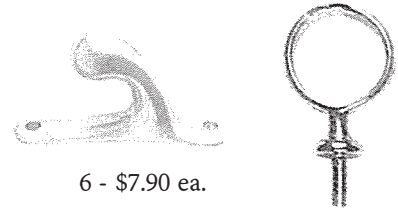

Hoof Dressing Quart with brush \$13.65 ea.

2 - \$12.00 ea.

Hoof Wormer Natural Powder \$9.00 ea.

2 - \$8.50 ea.



Head Block Hickory. 1 1/4" or 1 1/2" thick for top fifth wheel.

Fancy End \$7.00 ea. 3 - \$6.00 ea. 6 - \$5.80 ea.
 Blunt End \$6.00 ea. 3 - \$5.60 ea. 6 - \$5.30 ea.



Hub Core Drilling

To fit your boxing before wheel is assembled
 \$9.00 ea.

#1 Hub Core 1 1/16" Spoke \$11.00 ea.
 #2 Hub Core 1 1/8" Spoke \$11.90 ea.
 #3 Hub Core 1 1/4" Spoke \$12.50 ea.
 #4 Hub Core 1 1/2" Spoke \$13.60 ea.

Flanges - \$11.00 ea.
 Flanges - \$12.00 ea.
 Flanges - \$13.50 ea.
 Flanges - \$14.75 ea.

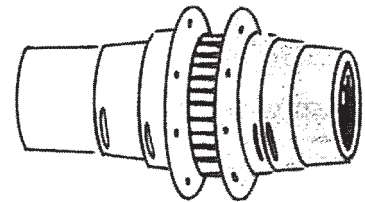

Horse Diaper Straps to harness
 \$32.40 ea. Pony - \$30.00 ea.

Gimp Binding Vinyl

Double Fold, 3/4" wide. Black, brown, green, blue, or wine.
 \$0.50 /yard 30 yards - \$0.40 /yard 50 yards - \$0.35 /yard



Eagle Head Brass
 \$16.00 pair
 2 - \$15.00 ea.

Gimp Binding Plastic

Extruded, 1/2", Black
 \$0.80 /yard 20 yards - \$0.70 /yard

Hidem Welt Black. 5/8" wine, brown, grey
 \$0.70 /yard 25 yards - \$0.65 /yard 50 yards - \$0.60 /yard

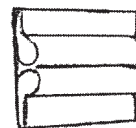

Grease EP302

Oz. Tube - \$4.00 2 - \$3.90 4 - \$3.70

Glue Aerosol, Foam & Fabric, 12 oz.- \$7.00 4 - \$6.50 ea. 6 - \$6.25 ea.

